

# JVC

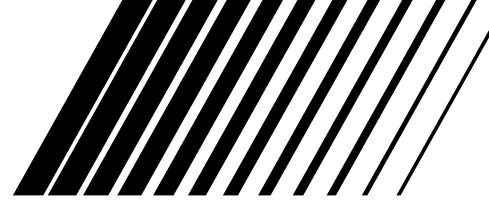

## COMPACT COMPONENT SYSTEM

# MX-KA6

Consists of CA-MXKA6 and SP-MXKA6

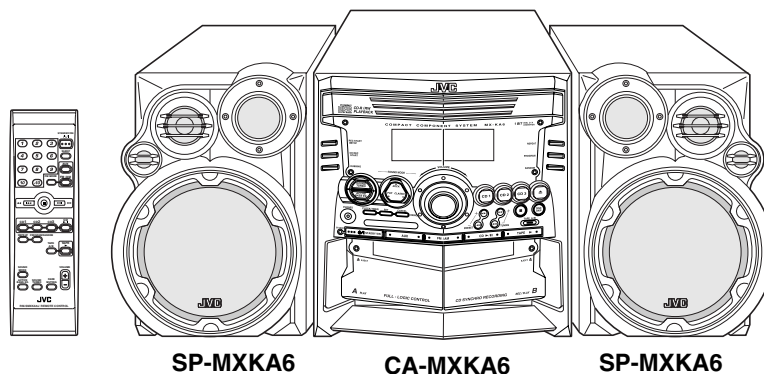

COMPACT  
**disc**  
DIGITAL AUDIO

## INSTRUCTIONS

**For Customer Use:**

Enter below the Model No. and Serial No. which are located either on the rear, bottom or side of the cabinet. Retain this information for future reference.

Model No. \_\_\_\_\_

Serial No. \_\_\_\_\_

LVT1014-001A

[J]

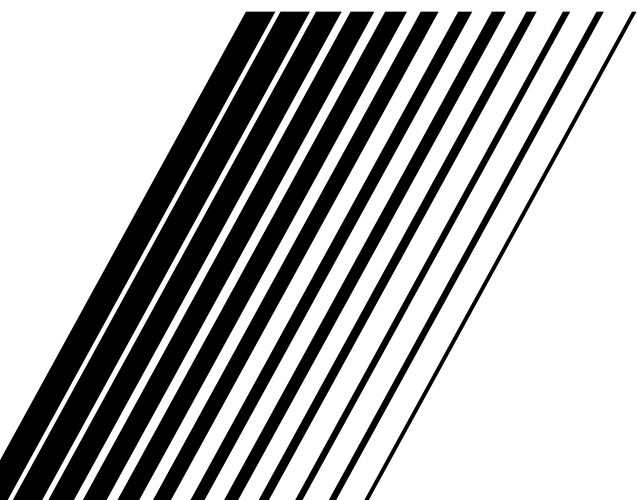

# Warnings, Cautions and Others

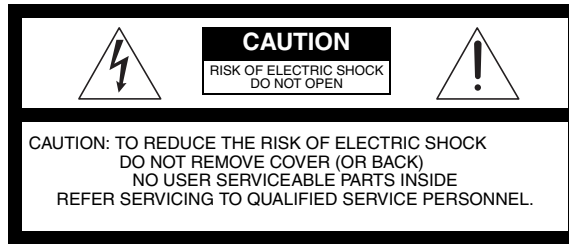

The lightning flash with arrowhead symbol, within an equilateral triangle is intended to alert the user to the presence of uninsulated “dangerous voltage” within the product’s enclosure that may be of sufficient magnitude to constitute a risk of electric shock to persons.



The exclamation point within an equilateral triangle is intended to alert the user to the presence of important operating and maintenance (servicing) instructions in the literature accompanying the appliance.

**WARNING: TO REDUCE THE RISK OF FIRE OR ELECTRIC SHOCK, DO NOT EXPOSE THIS APPLIANCE TO RAIN OR MOISTURE.**

**Note to CATV system installer:**

This reminder is provided to call the CATV system installer’s attention to section 820-40 of the NEC which provides guidelines for proper grounding and, in particular, specifies that the cable ground shall be connected to the grounding system of the building, as close to the point of cable entry as practical.

**For U.S.A.**

This equipment has been tested and found to comply with the limits for a Class B digital device, pursuant to Part 15 of the FCC Rules. These limits are designed to provide reasonable protection against harmful interference in a residential installation. This equipment generates, uses, and can radiate radio frequency energy and, if not installed and used in accordance with the instructions, may cause harmful interference to radio communications. However, there is no guarantee that interference will not occur in a particular installation. If this equipment does cause harmful interference to radio or television reception, which can be determined by turning the equipment off and on, the user is encouraged to try to correct the interference by one or more of the following measures:

- Reorient or relocate the receiving antenna.
- Increase the separation between the equipment and receiver.
- Connect the equipment into an outlet on a circuit different from that to which the receiver is connected.
- Consult the dealer or an experienced radio/TV technician for help.

CLASS 1 LASER PRODUCT

**DANGER**

- 1. Invisible laser radiation when open and interlock failed or defeated. Avoid direct exposure to beam.

**CAUTION**

- 1. Do not open the top cover. There are no user serviceable parts inside the unit; leave all servicing to qualified service personnel.
- 2. Use of controls, adjustments or performance of procedures other than those specified herein may result in hazardous radiation exposure.

**CAUTION**

To reduce the risk of electric shocks, fire, etc.:

- 1. Do not remove screws, covers or cabinets.
- 2. Do not expose this appliance to rain or moisture.
- 3. To prevent electric shock, match wide blade of plug to wide slot, fully insert.

**Caution — POWER switch!**  
Disconnect the main plug to shut the power off completely. The POWER switch in any position does not disconnect the main line. The power can be remote controlled.

**CAUTION**

- 1. Do not block the ventilation openings or holes. (If the ventilation openings or holes are blocked by a newspaper or cloth, etc., the heat may not be able to get out.)
- 2. Do not place any naked flame sources, such as lighted candles, on the apparatus.
- 3. When discarding batteries, environmental problems must be considered and local rules or laws governing the disposal of these batteries must be followed strictly.
- 4. Do not expose this apparatus to rain, moisture, dripping or splashing and that no objects filled with liquids, such as vases, shall be placed on the apparatus.

**Caution: Proper Ventilation**

To avoid risk of electric shock and fire, and to prevent damage, locate the apparatus as follows:

- 1. Front:  
No obstructions and open spacing.
- 2. Sides/ Top/ Back:  
No obstructions should be placed in the areas shown by the dimensions below.
- 3. Bottom:  
Place on the level surface. Maintain an adequate air path for ventilation by placing on a stand with a height of 10cm (3<sup>15</sup>/<sub>16</sub> in.) or more.

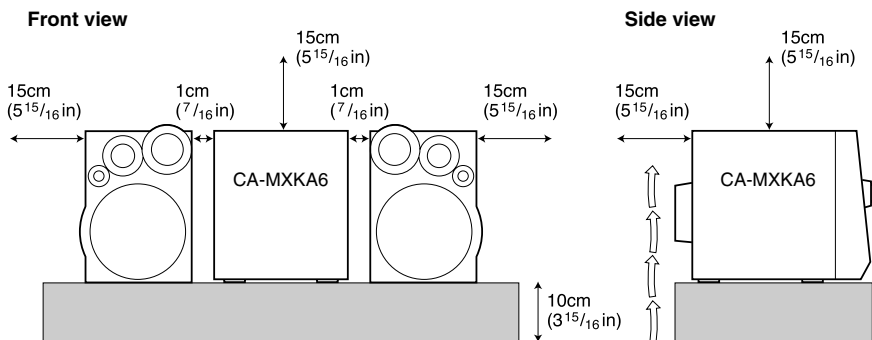

# Introduction

Thank you for purchasing the JVC Compact Component System.

We hope it will be a valued addition to your home, giving you years of enjoyment.

Be sure to read this instruction manual carefully before operating your new stereo system.

In it you will find all the information you need to set up and use the system.

If you have a query that is not answered by the manual, please contact your dealer.

---

## Features

---

Here are some of the things that make your System both powerful and simple to use.

- The controls and operations have been redesigned to make them very easy to use, freeing you to just enjoy the music.
  - With JVC's COMPU PLAY you can turn on the System and automatically start the Radio, Cassette Deck, or CD Player with a single touch.
- The great SEA (Sound Effect Amplifier) effects Rock, Pop and Classics are provided.
- The Active Bass EX. (Extension) circuitry faithfully reproduces low frequency sounds.
- The Sound Turbo function provides emphasized rich sound.
- A 45-station preset capability (30 FM and 15 AM) in addition to auto-seek and manual tuning.
- CD changer function can operate 3 discs.
  - Discs can be changed during play using the Carrousel tray (rotational tray).
  - Continuous, random or program play of 3 discs.
- Two Decks enabling tape dubbing.
- Timer functions; Daily Timer, REC (Recording) Timer, and Sleep Timer.
- You can connect various external units, such as an MD recorder.
- The CD Player can play back a CD-R and CD-RW.



---

## How This Manual Is Organized

---

- Basic information that is the same for many different functions - e.g. setting the volume - is given in the section "Basic Operations", and not repeated under each function.
- The names of buttons/controls and display messages are written in all capital letters: e.g. FM/AM, "NO DISC".
- If the button names on the Unit and the Remote Control are the same, the description on where the button is used will be omitted.
- System functions are written with an initial capital letter only: e.g. Normal Play.

Use the table of contents to look up specific information you require.

We have enjoyed making this manual for you, and hope it serves you in enjoying the many features built into your System.

---

## IMPORTANT CAUTIONS

---

### 1 Installation of the System

- Select a place which is level, dry and neither too hot nor too cold. (Between 5°C and 35°C or 41°F and 95°F.)
- Leave sufficient distance between the System and a TV.
- Do not use the System in a place subject to vibrations.

### 2 Power cord

- Do not handle the power cord with wet hands!
- Some power is always consumed as long as the power cord is connected to the wall outlet.
- When unplugging the System from the wall outlet, always pull the plug, not the power cord.

### 3 Malfunctions, etc.

- There are no user serviceable parts inside. In case of system failure, unplug the power cord and consult your dealer.
- Do not insert any metallic object into the System.

# Table of Contents

<b>Introduction .....</b>	<b>1</b>
Features.....	1
How This Manual Is Organized.....	1
IMPORTANT CAUTIONS.....	1
<b>Table of Contents .....</b>	<b>2</b>
<b>Getting Started .....</b>	<b>3</b>
Accessories .....	3
How To Put Batteries In the Remote Control.....	3
Using the Remote Control .....	3
Connecting the FM Antenna.....	4
Connecting the AM Antenna.....	5
Connecting the Speakers .....	5
Connecting External Equipment.....	6
Connecting to the Wall Outlet .....	6
DEMO Mode .....	6
COMPU Play.....	6
<b>Basic Operations.....</b>	<b>7</b>
Turning the Power On and Off .....	7
Adjusting the Volume.....	7
Fade-out Muting (FADE MUTING).....	8
Reinforcing the Bass Sound (ACTIVE BASS EX.).....	8
Emphasizing the sound (SOUND TURBO).....	8
Selecting the Sound Mode (SOUND MODE).....	8
Entering the Number with the Remote Control (Numeric Keys).....	8
<b>Using the Tuner .....</b>	<b>9</b>
Tuning In a Station .....	9
Presetting Stations .....	10
To Change the FM Reception Mode .....	10
<b>Using the CD Player .....</b>	<b>11</b>
To Load CDs .....	12
To Unload CDs.....	12
Basics of Using the CD Player-Normal Play.....	13
Programming the Playing Order of the Tracks.....	14
Random Play.....	15
Repeating Tracks .....	15
Tray Lock Function .....	15
<b>Using the Cassette Deck (Listening to a Tape) .....</b>	<b>16</b>
Playing a Tape .....	16
<b>Using the Cassette Deck (Recording) .....</b>	<b>17</b>
Standard Recording .....	18
CD Synchro Recording.....	18
Tape to Tape Recording (DUBBING).....	18
<b>Using an External Equipment .....</b>	<b>19</b>
Listening to the External Equipment.....	19
<b>Using the Timers .....</b>	<b>20</b>
Setting the Clock .....	20
Setting the Daily Timer .....	21
Setting the REC (Recording) Timer .....	22
Setting the SLEEP Timer .....	24
Timer Priority .....	24
<b>Care And Maintenance.....</b>	<b>25</b>
<b>Troubleshooting .....</b>	<b>26</b>
<b>Specifications .....</b>	<b>Back cover</b>

# Getting Started

## Accessories

Make sure that you have all of the following items, which are supplied with the System.

- AM Loop Antenna (1)
- FM Wire Antenna (1)
- Remote Control (1)
- Batteries (2)

If any of these items are missing, contact your dealer immediately.

## How To Put Batteries In the Remote Control

Match the polarity (+ and -) on the batteries with the + and - markings in the battery compartment.

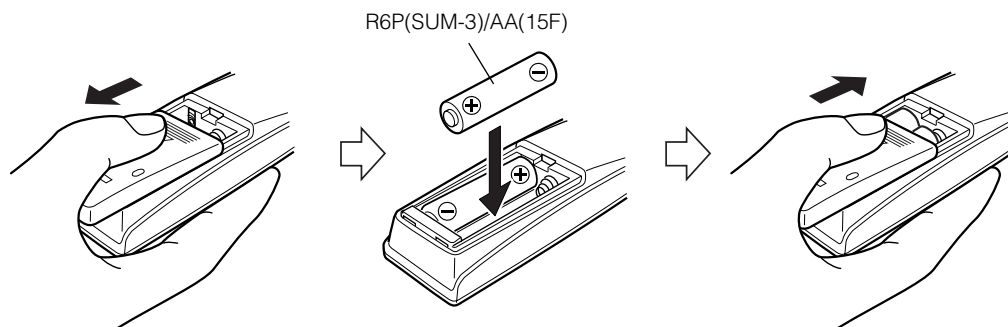

### **CAUTION:**

- Handle batteries properly.

To avoid battery leakage or explosion:

- Remove batteries when the Remote Control will not be used for a long time.
- When you need to replace the batteries, replace both batteries at the same time with new ones.
- Do not use an old battery with a new one.
- Do not use different types of batteries together.

## Using the Remote Control

The Remote Control makes it easy to use many of the functions of the System from a distance of up to 7m (23 feet) away. You need to point the Remote Control at the remote sensor on the System's front panel.

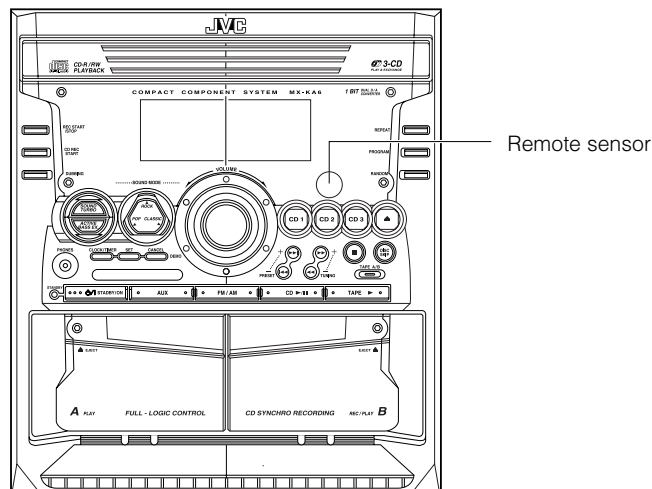

**CAUTION:**

- Make all connections before plugging the System into an AC power outlet.

## Connecting the FM Antenna

### Using the Supplied Wire Antenna

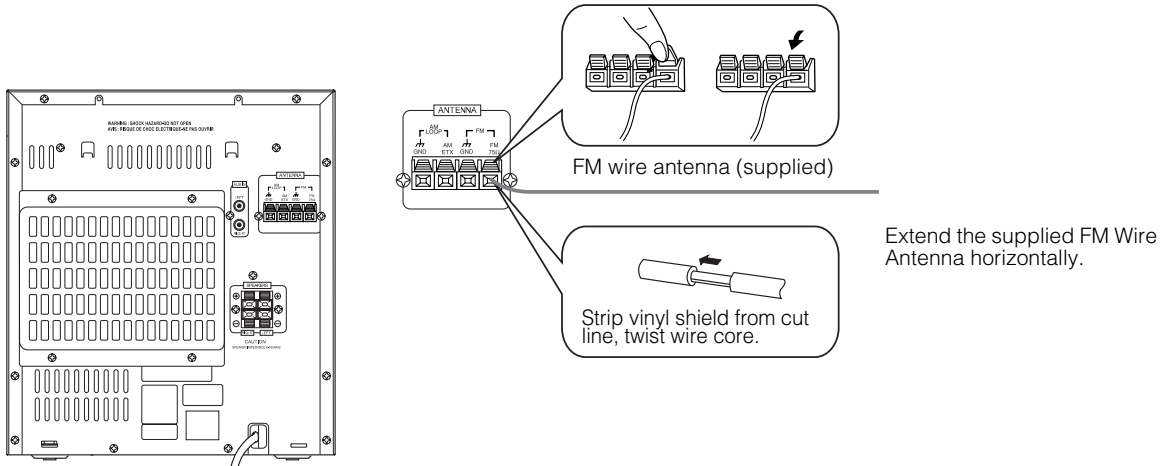

### Using an FM 75-Ohm Antenna Cable (not Supplied)

If reception is poor, connect the outside antenna.

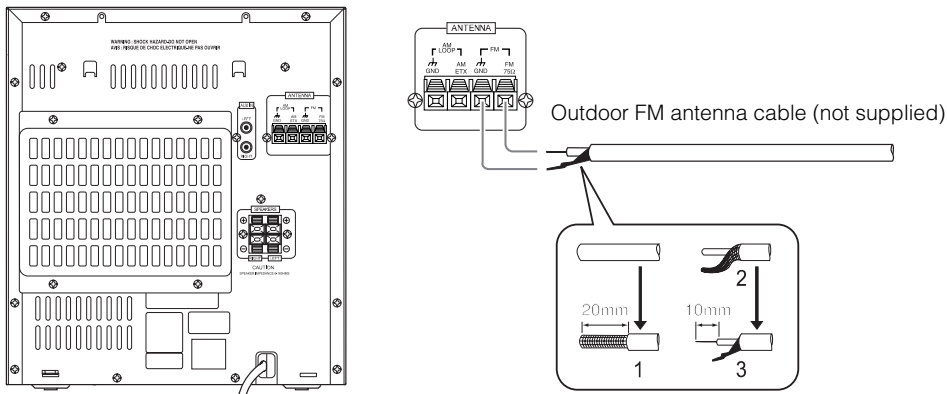

**Note**

- Before attaching a 75 ohm coaxial lead (the kind with a round wire going to an outdoor antenna), disconnect the supplied FM Wire Antenna.

## Connecting the AM Antenna

### Rear Panel of the Unit

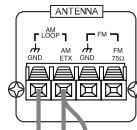
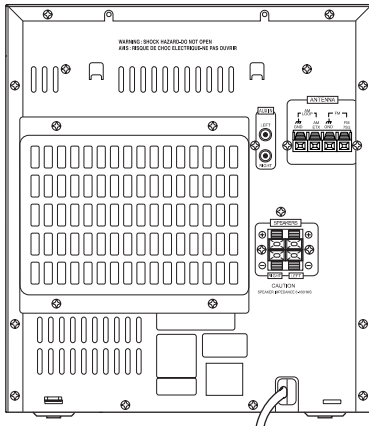

AM antenna wire (not supplied)  
If reception is poor, connect the outside antenna.

Turn the loop until you have the best reception.

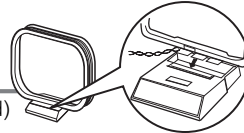

AM loop antenna (Supplied)

Attach the AM loop to its base by snapping the tabs on the loop into the slot in the base.



• Even when connecting an outside AM antenna, keep the indoor AM loop connected.

### CAUTION:

• To avoid noise, keep antennas away from the System, the connecting cord and the AC power cord.

## Connecting the Speakers

Connect the right speaker to the RIGHT speaker terminals and the left speaker to the LEFT speaker terminals. “Right” / “Left” is labeled on the rear of the speaker.

1. Open each of the terminals to connect the speaker wire leads.
2. Connect the speaker cords to the Speaker terminals of the Unit.

Connect the red (+) and black (-) cords of the right side speaker to the red (+) and black (-) terminals marked RIGHT on the System.

Connect the red (+) and black (-) cords of the left side speaker to the red (+) and black (-) terminals marked LEFT on the System.

3. Close each of the terminals.

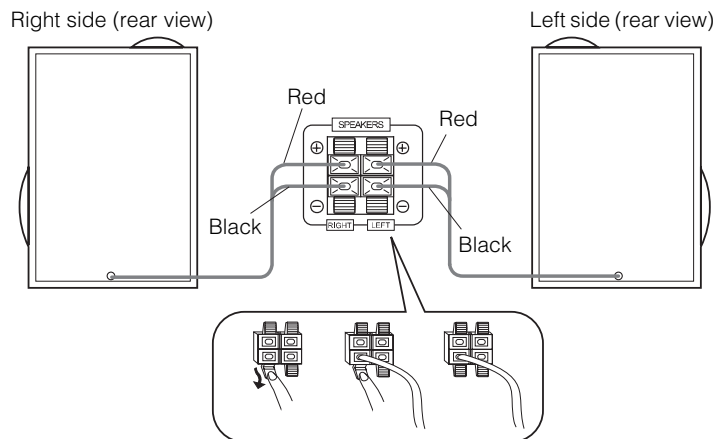

### CAUTIONS:

- A TV may display irregular colors if located near the speakers. If this happens, set the speakers away from the TV.
- Use speakers with the correct impedance only. The correct impedance is indicated on the rear panel.



## Connecting External Equipment

Connect a signal cord (not supplied) between the System's AUX-IN terminals and the output terminals of the external MD recorder, tape deck, etc.

You can then listen to the external source through the System.

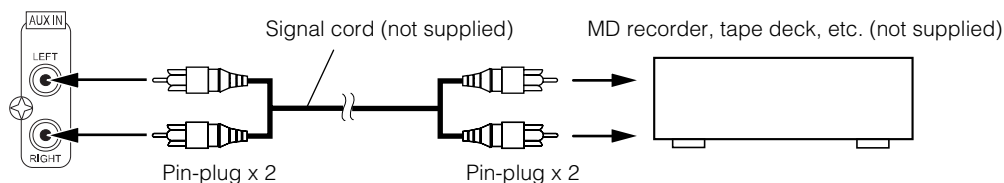

## Connecting to the Wall Outlet

Plug the AC power cord into the wall outlet.

Now, your System is at your command!

## DEMO Mode

When the System is connected to the wall outlet, a DEMO mode displaying some of the system's features automatically starts.

**To turn the DEMO display off**, press any of the operation buttons. The DEMO display automatically stops.

**To turn the DEMO display on**, press the DEMO button on the Unit for more than 2 seconds.

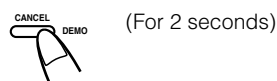

### Note

- While the System is turned on, the DEMO display will automatically start if no operation is made for 2 minutes. To cancel this auto DEMO display function, press the CANCEL button on the Unit during DEMO display.

## COMPU Play

JVC's COMPU PLAY feature lets you control the most frequently used System functions with a single touch.

With One Touch Operation you can play a CD, a tape, turn on the radio, or listen to an external equipment with a single press of the play button for that function. One Touch Operation turns the power on for you, then starts the function you have specified. If the System is not ready (no CD or tape in place), the System still powers on so you can insert a CD or tape.

How One Touch Operation works in each case is explained in the section dealing with that function.

The COMPU PLAY buttons are:

### On the Unit

- CD ►/|| button
- FM/AM button
- TAPE ► button
- AUX button
- CD1, CD2 and CD 3 buttons
- CD Open/Close ▲ button

### On the Remote Control

- CD ►/|| button
- FM/AM button
- TAPE ► button
- AUX button
- CD1, CD2 and CD 3 buttons

# Basic Operations

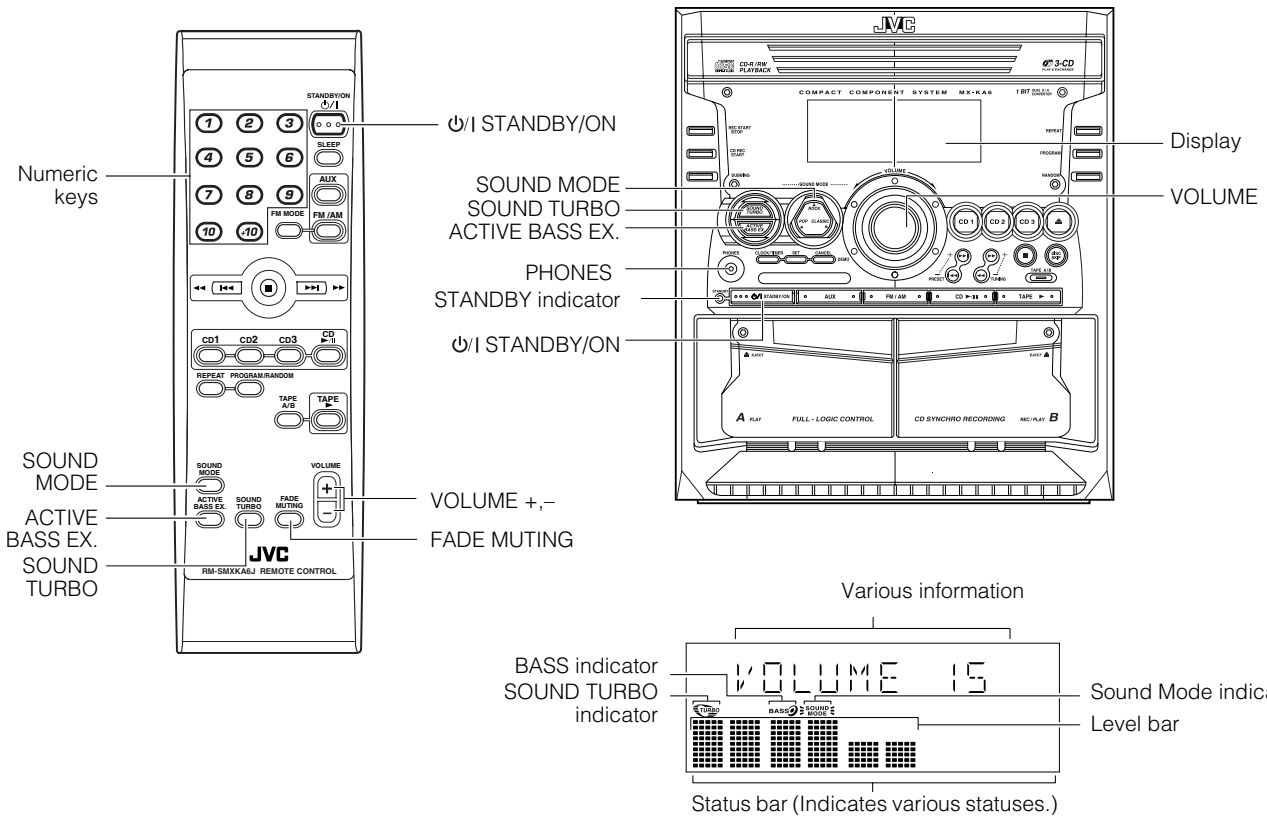

\* When the System is in use, the display shows other items as well. For simplicity, we show here only the items described in this section.

## Turning the Power On and Off

### Turning the System On

**1** Press the **⏻/⏻ STANDBY/ON** button.

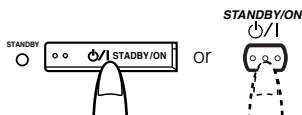

The display comes on and “WELCOME” is displayed once. The STANDBY indicator goes out.

The System comes on ready to continue in the mode it was in when the power was last turned off.

- For example, if the last thing you were doing was listening to a CD, you are now ready to listen to a CD again. If you wish, you can change to another source.
- If you were listening to the Tuner last, the Tuner comes on playing the station it was last set to.

### Turning the System Off

**1** Press the **⏻/⏻ STANDBY/ON** button again.

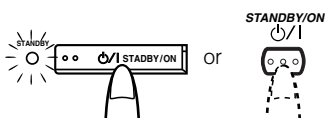

“GOOD BYE” is displayed and the display goes out, except for the clock display. The STANDBY indicator lights up. (The display is dimmed.)

- Some power is always consumed even though power is turned off (called Standby mode).

## Adjusting the Volume

Turn the VOLUME control on the Unit clockwise to increase the volume or turn it counterclockwise to decrease the volume. Press the VOLUME + button on the Remote Control to increase the volume or press the VOLUME – button on the Remote Control to decrease the volume.

VOLUME 15

You can set the volume level to MIN, 1-31, or MAX.

### CAUTION:

- **DO NOT** turn on the System and/or start playing any source without first setting the VOLUME control to minimum, as a sudden blast of sound could damage your hearing, speakers and/or headphones.

### For private listening

Connect a pair of headphones to the PHONES jack. No sound comes out of the speakers.

Be sure to turn down the volume before connecting or putting on headphones.

---

## **Fade-out Muting (FADE MUTING)**

---

You can mute the output with one touch operation.

**To muting the output**, press the FADE MUTING button on the Remote Control. The output is faded out.

**To release muting**, press the FADE MUTING button once again. The output is faded in to the previous level.

- After Fade-out Muting, turning the VOLUME control on the unit or pressing the VOLUME button on the Remote Control will increase the volume from MIN. setting.

---

## **Reinforcing the Bass Sound (ACTIVE BASS EX.)**

---

The richness and fullness of the bass sound is maintained regardless of how low you set the volume.

You can use this effect only for playback.

**To get the effect**, press the ACTIVE BASS EX. (Extension) button.

The “BASS” indicator lights up and “ACTIVE BASS EXTENSION” appears on the display.

**To cancel the effect**, press the button again.

The “BASS” indicator goes out and “OFF” appears on the display.

---

## **Emphasizing the sound (SOUND TURBO)**

---

High and low frequencies are highly boosted.

**To get the effect**, press the SOUND TURBO button.

The SOUND TURBO indicator lights up and “SOUND TURBO ON” appears on the display.

**To cancel the effect**, press the button again.

The SOUND TURBO indicator goes out and “OFF” appears on the display.

- Selecting the Sound Turbo function turns the Active Bass EX. and Sound Mode to off. While the Sound Turbo will be turned off, if either Active Bass EX. or Sound Mode function is selected.

---

## **Selecting the Sound Mode (SOUND MODE)**

---

You can select one of 3 SEA (Sound Effect Amplifier) modes.

You can use this effect only for playback.

### **On the Unit**

**To get the effect**, press one of the Sound Mode buttons, ROCK, POP, or CLASSIC.

The selected Sound Mode name “ROCK”, “POP”, or “CLASSIC” appears on the display. The “SOUND MODE” indicator also lights up on the display.

**To cancel the effect**, press the currently selected mode button again.

When the effect is canceled, the “SOUND MODE” indicator stays lit.

For example, if the current Sound Mode is ROCK, press the ROCK button again. “OFF” appears on the display, showing that no sound effect is applied.

<b>ROCK</b>	Boosts low and high frequencies. Good for acoustic music.
<b>POP CLASSIC</b>	Good for vocal music. Set for wide and dynamic sound stereo systems.
<b>OFF</b>	No sound effect applies.

### **On the Remote Control**

Press the SOUND MODE button until Sound Mode you want appears on the display.

The “SOUND MODE” indicator lights up in the display.

Each time you press the button, the Sound Mode changes as follows:

ROCK → POP → CLASSIC → OFF → (back to the beginning)

**To cancel the effect**, press the SOUND MODE button until “OFF” appears on the display.

The “SOUND MODE” indicator stays lit.

---

## **Entering the Number with the Remote Control (Numeric Keys)**

---

You will use the number keys on the Remote Control to enter numbers for presetting stations, recalling the preset stations, or programming the playing tracks on CDs.

How to enter the number with the number keys is explained here.

### **Examples:**

- To enter number 5, press 5.
- To enter number 15, press +10, then 5.
- To enter number 20, press +10, then 10.
- To enter number 25, press +10, +10, then 5.

# Using the Tuner

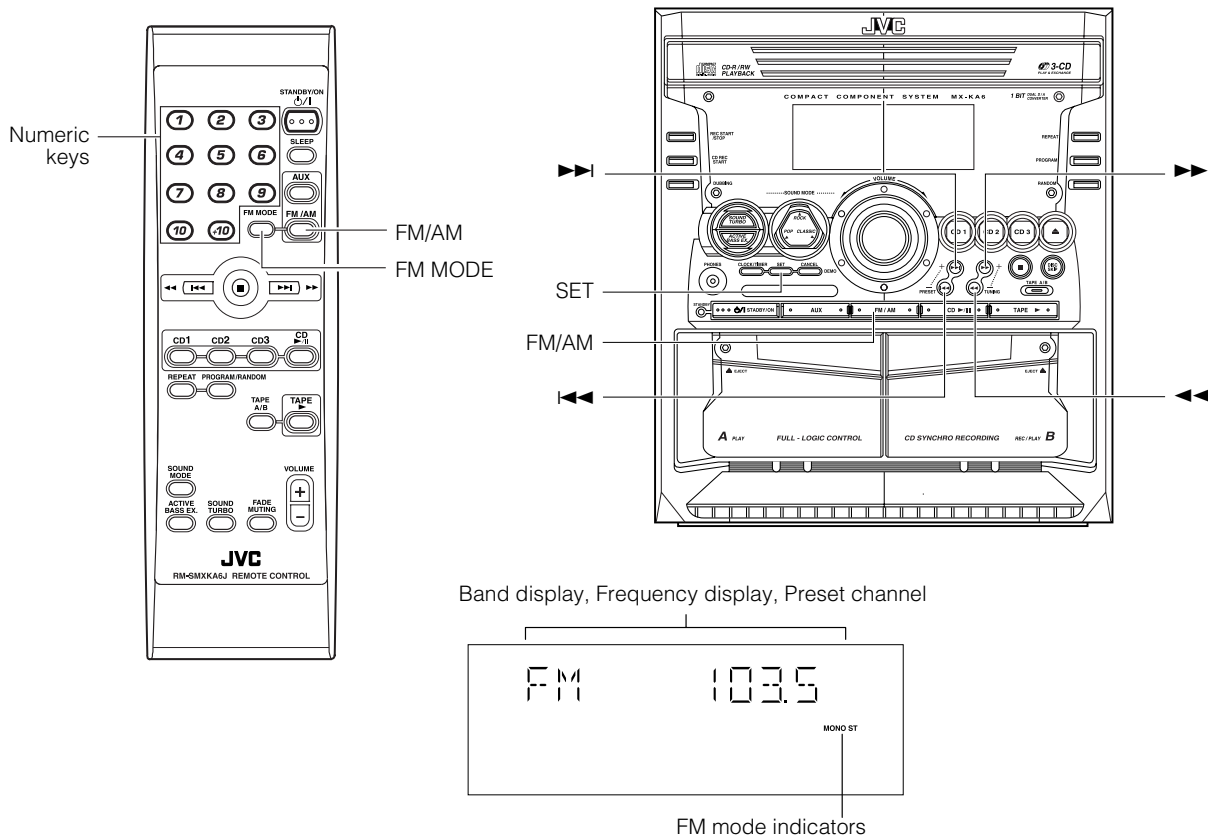

\* When the System is in use, the display shows other items as well. For simplicity, we show here only the items described in this section.

You can listen to FM and AM stations. Stations can be tuned in manually, automatically, or from preset memory storage.

Before listening to the radio:

- Make sure that both the FM and AM antennas are correctly connected. (See pages 4 and 5).

## One Touch Radio

Just press the FM/AM button to turn on the System and start playing the station you were last tuned to.

You can switch from any other sound source to the radio by pressing the FM/AM button.

## Tuning In a Station

### 1 Press the FM/AM button.

The Band and Frequency you were last tuned to appear on the display.

(If the last station was selected using the preset number, the preset number appears first.)

Each time you press the button, the band alternates between FM and AM.

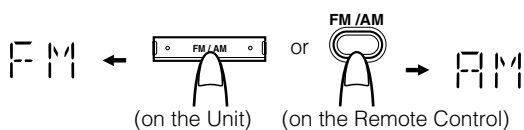

### 2 Select a station using one of the following methods.

#### • Manual Tuning (Using the Unit only)

Briefly press the ◀◀ or ▶▶ button on the Unit to move from frequency to frequency until you find the station you want.

OR

#### • Auto Tuning (Using the Unit only)

If you hold down the ◀◀ or ▶▶ button on the Unit for 1 second or more and then release it, the frequency changes down, or up, automatically until a station is found.

OR

#### • Preset Tuning (Possible only after presetting stations)

**Preset tuning using the Unit:**

Select the preset number you want, using the ◀◀ or ▶▶ button.

#### **Example:**

Press the ▶▶ button until the preset number "P12" appears on the display. Then, the display will show the preset number's band and frequency.

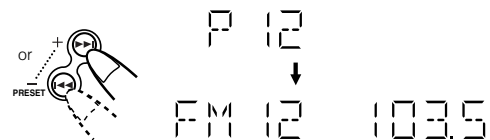

#### **Preset tuning using the Remote Control:**

Enter the preset number you want to recall using the numeric keys. See "Entering the Number with the Remote Control" on page 8.

#### **Example:**

Press +10, then 2 to recall the preset number 12. Then, the display will show the preset number's band and frequency.



- In AM broadcast, reception sensitivity will be changed by turning the AM loop antenna. Turn the AM loop antenna for best reception.

## Presetting Stations

You can preset up to 30 FM stations and up to 15 AM stations.



- Preset numbers may have been set to factory test frequencies prior to shipment. This is not a malfunction. You can preset the stations you want into memory by following one of the presetting methods below.
- During presetting stations, if no button operation is made for 5 seconds, the display returns to the band/frequency display. In this case, repeat steps from the beginning.

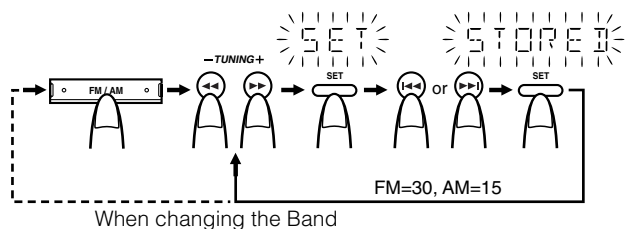

## Using the Unit

- 1 Select a band by pressing the FM/AM button.**
- 2 Press the ◀◀ or ▶▶ button to tune in a station.**
- 3 Press the SET button.**  
“SET” will blink for 5 seconds.
- 4 Press the |◀◀ or ▶▶| button to select the preset number.**  
▶▶: Increases the preset number by 1.  
◀◀: Decreases the preset number by 1.
- 5 Press the SET button.**  
“STORED” appears and, after 2 seconds, the display returns to the band/frequency display.
- 6 Repeat above steps 2 to 5 for each station you want to store in memory with a preset number.**

To change the preset stations, repeat the same steps as above.



- In step 4, you can select the preset number using the numeric keys on the Remote Control. See “Entering the Number with the Remote Control” on page 8.

## CAUTION:

- Even if the System is unplugged or if the power failure occurs, the preset stations will be stored for a few days. However, in case the preset stations are erased, you will need to preset the stations again.

## To Change the FM Reception Mode

When you are tuned in to an FM stereo broadcast, the “ST (Stereo)” indicator lights up and you can hear stereo effects. If an FM stereo broadcast is hard to receive or noisy, you can select Monaural mode. Reception improves, but you lose stereo effect.

Press the FM MODE button on the Remote Control so that the “MONO” indicator lights up on the display.

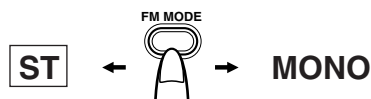

To restore the stereo effect, press the FM MODE button on the Remote Control so that the “MONO” indicator goes off. Selecting other station will also cancel the FM Mono mode and restore the stereo effect.

# Using the CD Player

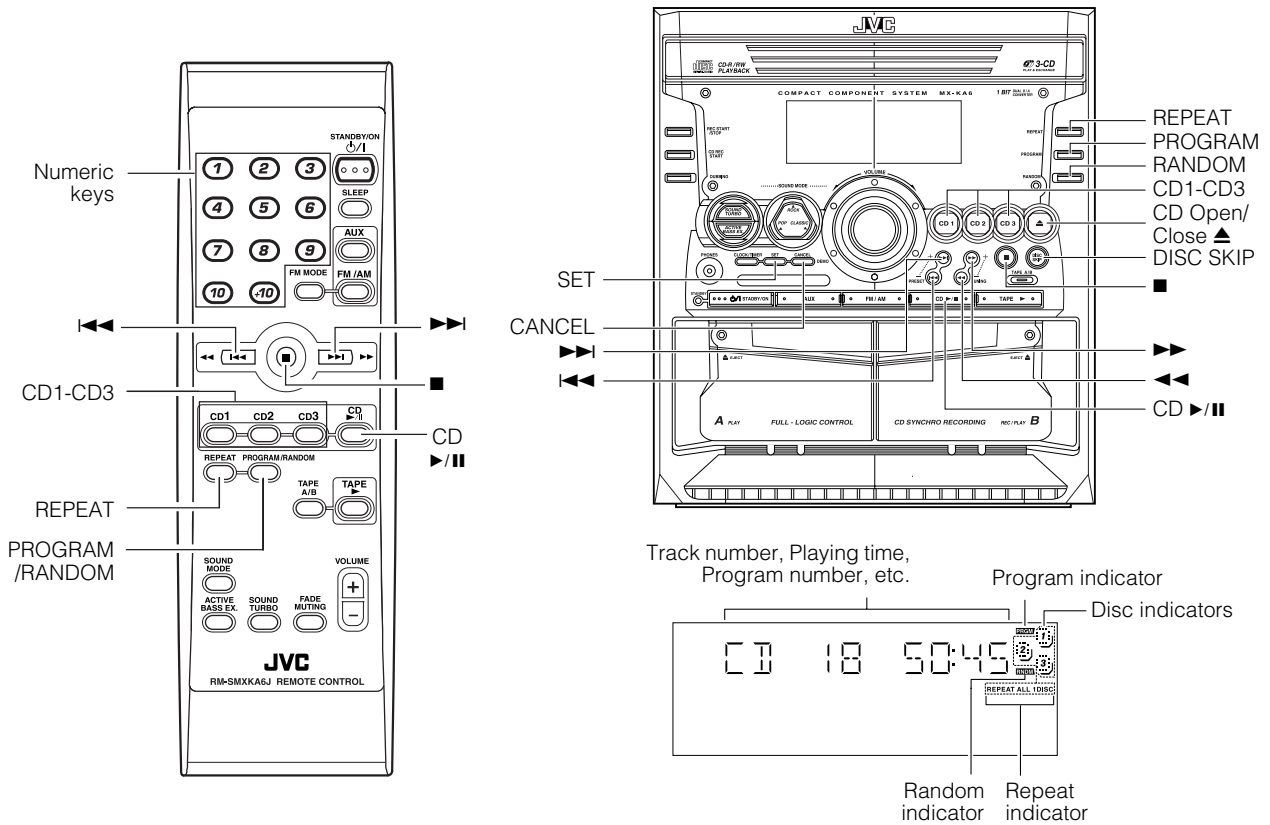

\* When the System is in use, the display shows other items as well. For simplicity, we show here only the items described in this section.

The CD Player has the rotational disc tray that can accommodate 3 CDs.

You can use Normal, Program, Random, or Repeat Play.

- Normal Play** : Can continuously play all the tracks on all the CDs.
- Program Play** : Can play all the programmed tracks on all the CDs in the programmed order.
- Random Play** : Can play all the tracks on all the CDs in random order.
- Repeat Play** : Can repeat all the tracks on all the CDs, the tracks on one of the CDs, or just one of tracks on one CD.

Here are the basic things you need to know to play CDs and locate the different tracks on them.

## About the Disc Indicator

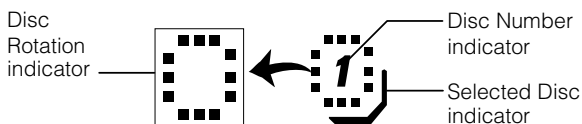

The Disc indicator consists of the following three kinds of indicators:

- Disc Number indicator:** Lights all the time.
- Selected Disc indicator:** Lights for the currently selected disc number.

**Disc Rotation indicator:** Runs when the selected CD is playing or paused. This indicator goes out if a CD is not loaded for the selected disc number. Once the tray is ejected, the Disc Rotation indicators for all disc numbers are lit. However, when the empty disc number is selected, the Disc Rotation indicator for the disc number goes out.

### Example of indication:

When CD tray has ejected once and then CD1 is pressed. (DISC1 is selected)

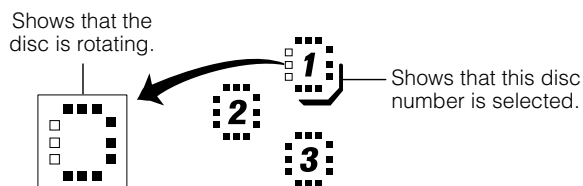

### One Touch Play

The power comes on, and operations are done automatically.

- ❑ By pressing the CD ►/|| button, the System will come on, and if a CD is loaded for the disc number that was lastly selected, it will start playing from the first track.
- ❑ By pressing the CD1-CD3 button, the System will come on, and if a CD is already loaded for the selected disc number, it will start play from the first track.

### To Load CDs

**1 Press the CD Open/Close ▲ button on the Unit to open the tray.**

**2 Place a CD, with its label side up, onto the tray.**

Be sure that the CD is securely seated on the disc tray.

With the label side up

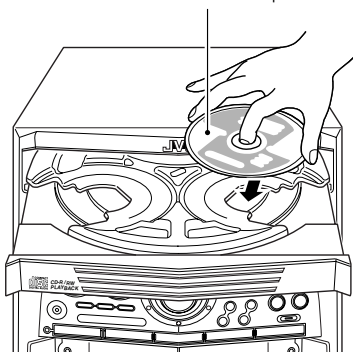

**3 Press the DISC SKIP button on the Unit and place the next CD.**

When you press the button, the tray turns for the next CD.

**4 Repeat step 3 for the last CD.**

**5 Press the CD Open/Close ▲ button on the Unit.**

The tray is closed.



- When placing a disc in the tray, be sure to position the disc inside the recess correctly. Otherwise, the message "NO DISC" will appear in the display, and the disc may be damaged or the unit may be damaged when the tray is opened, or it may be difficult to remove the disc from the unit.

- ❑ When you use an 8 cm (3") CD, place it on the inner circle of the tray.
- ❑ You can load CDs while listening to the other source or while listening to the CD being played back.
- ❑ When power is turned off with the tray opened, the tray is automatically closed.
- ❑ If the CD cannot be read correctly (because it is scratched, for example), "00. 00:00" appears on the display.

### To Unload CDs

Take out the CD as shown below.

**1 While the CD Player is stopped, press the CD Open/Close ▲ button on the Unit to open the tray.**

**2 Remove the CD, then press the DISC SKIP button on the Unit.**

The tray turns for the next CD.

**3 Repeat step 2 to remove all the CDs.**

**4 Press the CD Open/Close ▲ button on the Unit to close the tray.**

- ❑ You can remove CDs while listening to the other source.



- You can also remove the CDs during playback. However, in this case, you can only remove the CDs that are not being played back.

## Basics of Using the CD Player- Normal Play

### To Play CDs

#### 1 Load CDs.

#### 2 Press one of the Disc button (CD1-CD3) you want to play.

The selected disc number (e.g. "CD DISC 1") appears on the display.

The first track of the selected CD begins playing. When the first CD finishes playing, the next and the third CDs are continuously played back.

When the last CD has finished playing, the CD Player automatically stops.

#### Examples:

CD1 → CD2 → CD3 → (stop)

CD2 → CD3 → CD1 → (stop)

- You can start to play the currently selected disc by simply pressing the CD ►/|| button.

While playing the CD, the following will appear on the display.

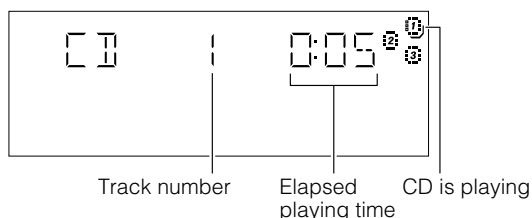

- When the Disc button (CD1-CD3) is pressed with the tray opened, the tray is closed and the selected CD automatically begins playing.

**To stop playing the CD**, press the ■ button. The following information for the CD is displayed.

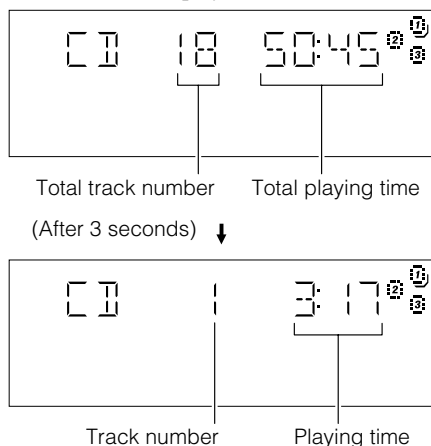

**To pause**, press the CD ►/|| button. The playing time indication blinks on the display.

**To cancel pause**, press the CD ►/|| button again. Play continues from the point where it was paused.

**To remove the CD**, stop playing and press the CD Open/Close ▲ button on the Unit.

#### Tips:

##### • Playing back the CD using the DISC SKIP button

You can also play the CDs using the DISC SKIP button. During playback, each time you press the button, the next CD is automatically played back. If the next disc tray is empty, the disc tray is automatically skipped.

##### • Removing/changing the CDs during playback

While playing back a CD (e.g. CD1), you can remove or change the other CDs (e.g. CD2 and CD3) by pressing the CD Open/Close ▲ button. After removing or changing, press the same button to close the tray.

### To Select a Track

#### During playback (using the ◀◀ or ▶▶ button):

Briefly press the ◀◀ or ▶▶ button to select the track you want to play.

By pressing the button, you can skip to the next track or skip back to the previous track.

- The selected track starts playing.
- Press the ▶▶ button once to skip to the beginning of the next track. (You can skip to the next CD (e.g. CD1 → CD2 → CD3).)
- Press the ◀◀ button to skip to the beginning of the current track. Press twice quickly to skip to the beginning of the previous track. (You cannot skip back to the previous CD.)

#### In Stop mode (using the ◀◀ or ▶▶ button):

By briefly pressing the ◀◀ or ▶▶ button, the CD Player operates in the same way as during playback, except the following point.

- The buttons are effective only for the currently selected CD.

#### Using the numeric keys on the Remote Control:

Using the numeric keys, you can directly select the track on the currently selected CD.

- The selected track starts playing.
- For example, press +10, then 5 to play back the track number 15. See "Entering the Number with the Remote Control" on page 8.

### Search Play

Holding down the following buttons, during playback, will fast forward/backwards the CD so you can quickly find a particular passage in the track you are listening to.

- ◀◀ or ▶▶ button on the Unit
- ◀◀ or ▶▶ button on the Remote Control



## Programming the Playing Order of the Tracks

You can program the playing order of the tracks on all the CDs. Note that you can only make a program when the CD Player is stopped.

- You can program up to 32 tracks in any desired order including the same tracks.

### To Make a Program

#### 1 Load CDs

#### 2 In Stop mode, set the CD Player in Program Play mode.

##### On the Unit

Press the PROGRAM button to light the “PRGM” indicator on the display.

At the same time, “PROGRAM” appears on the display.

##### On the Remote Control

Press the PROGRAM/RANDOM button until “PROGRAM” appears on the display.

The “PRGM” indicator also lights up on the display.

Each time you press the button, the display changes as follows:

PROGRAM → RANDOM → Normal display (Normal Play) →

(back to the beginning)

- If a program is already made, the last step of the program will be displayed.

#### 3 Press one of the Disc button (CD1-CD3) to select the CD you want to program.

The display will change to the Program Entry display.

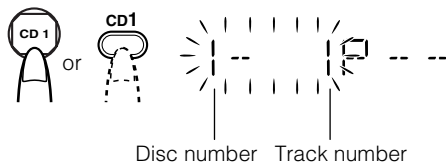

#### 4 Select the track you want to program.

##### Using the Unit

While the display is blinking, press the ◀◀ or ▶▶ button to select the track, then press the SET button within 5 seconds.

The program order number will be assigned from P-1.

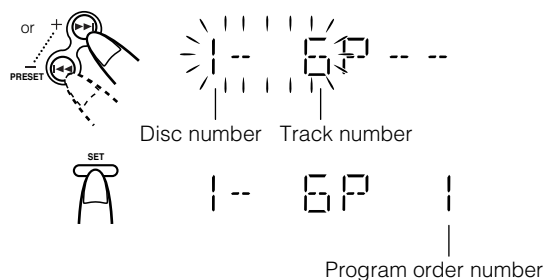

##### Using the Remote Control

Press the numeric keys to directly enter the track number. Then, the program order number will be assigned from P-1.

- To delete the current program step, press the CANCEL button on the Unit.

#### 5 Repeat steps 3 and 4 to program other tracks on the same CD or the other CD.

#### 6 To play the program, Press the CD ▶/|| button.

For details, see “To Play the Program You Have Made” mentioned below.

**To confirm the programmed contents**, while the CD player is stopped, press the ◀◀ or ▶▶ button on the Remote Control.

**To delete all the tracks in the program**, while the CD Player is stopped, press the ■ button.

**To Modify the Program**, while the CD Player is stopped, press the CANCEL button, the last track in the program is deleted. To add new tracks to the end of the program, repeat above steps 3 and 4.

#### Notes

- If you try to program a track number that does not exist on the CD, your entry will be ignored.
- If you try to program the 33rd track, “FULL” appears on the display.

### To Play the Program You Have Made

Press the CD ▶/|| button.

The System plays the tracks in the order you have programmed them.

- To use Repeat Play for Program Play, press the REPEAT button to select “ALL” or “1” before starting playback. For details, see “Repeating Tracks” on page 15.

- You can skip to a particular program track by pressing the ◀◀ or ▶▶ button during Program Play.

- To stop playing, press the ■ button once. If you press the ■ button, while the CD Player is stopped, the program is deleted.

### To Exit and Re-enter Program Play

The program you have made is stored in memory. So, you can exit Program Play temporarily or re-enter Program Play unless you delete the program.

**To exit the program mode once**, while the CD Player is stopped, press the PROGRAM button on the Unit or the PROGRAM/RANDOM button on the Remote Control to light off the “PRGM” indicator. By changing the source to the other (e.g. Tuner), the CD Player also exits Program Play mode.

**To re-enter Program Play mode**, press the PROGRAM or PROGRAM/RANDOM button until the “PRGM” indicator lights up again.

#### Note

- Even when the power is turned off (standby mode), the programmed tracks are not deleted. So, you can re-enter Program Play mode.

### Random Play

The tracks of all the CDs will play in no special order when you use this mode.

- To use Repeat Play for Random Play, press the REPEAT button to select “REPEAT ALL” or “REPEAT 1” before starting playback. For details, see “Repeating Tracks” mentioned below.

#### 1 In Stop mode, set the CD Player in Random Play mode.

##### On the Unit

Press the RANDOM button to light the “RNDM” indicator. At the same time, “RANDOM” appears on the display.

##### On the Remote Control

Press the PROGRAM/RANDOM button until the “RANDOM” appears on the display.

The “RNDM” indicator also lights up on the display.

Each time you press the button, the display changes as follows: PROGRAM → RANDOM → Normal display (Normal Play) → (back to the beginning)

#### 2 Press the CD ►/|| button.

The tracks on all the CDs are played in random order.

**To stop playing**, press the ■ button.

**To skip a track during playback**, press the ►| button to jump to the next track in the random sequence.

**To exit Random Play mode**, while the CD Player is stopped, press the RANDOM button on the Unit or the PROGRAM/RANDOM button on the Remote Control again to light off the “RNDM” indicator. Normal Play resumes.

### Repeating Tracks

You can repeat all tracks or individual track, as many times as you like.

#### Press the REPEAT button.

The Repeat indicator changes with each press of the button, as follows:

REPEAT ALL → REPEAT 1DISC → REPEAT 1 → Blank display → (back to the beginning)

**REPEAT ALL:** In Normal Play mode, repeats all the tracks on all the CDs.  
In Program Play mode, repeats all the tracks in the program.  
In Random Play mode, repeats all the tracks on all the CDs in random order.

**REPEAT 1DISC:** Repeats all tracks on one CD. (Selectable in Normal Play only)

**REPEAT 1:** Repeats one track.

**To stop playing**, press the ■ button. Changing the source to the other (e.g. Tuner) will also stop playing.

**To exit Repeat mode**, press the REPEAT button until the Repeat indicator on the display goes out.

☐ Repeat mode remains in effect during the following Play Mode changing:

- a. PROGRAM PLAY MODE ↔ NORMAL PLAY MODE
- b. RANDOM PLAY MODE ↔ NORMAL PLAY MODE
- c. PROGRAM PLAY MODE ↔ RANDOM PLAY MODE

### Tray Lock Function

In order to safely keep the CD in the CD Player, the tray can be electronically locked.

When the electronic lock is on, the tray cannot be opened even if the CD Open/Close ▲ button on the Unit is pressed.

#### Locking the Tray

##### 1 Turn on the System and enter CD mode.

##### 2 While pressing down the ■ button, press the CD Open/Close ▲ button on the Unit.

“LOCKED” appears on the display.



- If you try to open the tray by pressing the ▲ button, “LOCKED” appears on the display to let you know that the tray has been locked.

#### Unlocking the Tray

Repeat above steps 1 and 2.

“UNLOCKED” appears on the display.



Now, you can use the tray normally.



- Even after the System is unplugged, the tray lock condition will be retained for a few days. To unlock the tray after powering up, you need to perform the unlocking operation.

# Using the Cassette Deck (Listening to a Tape)

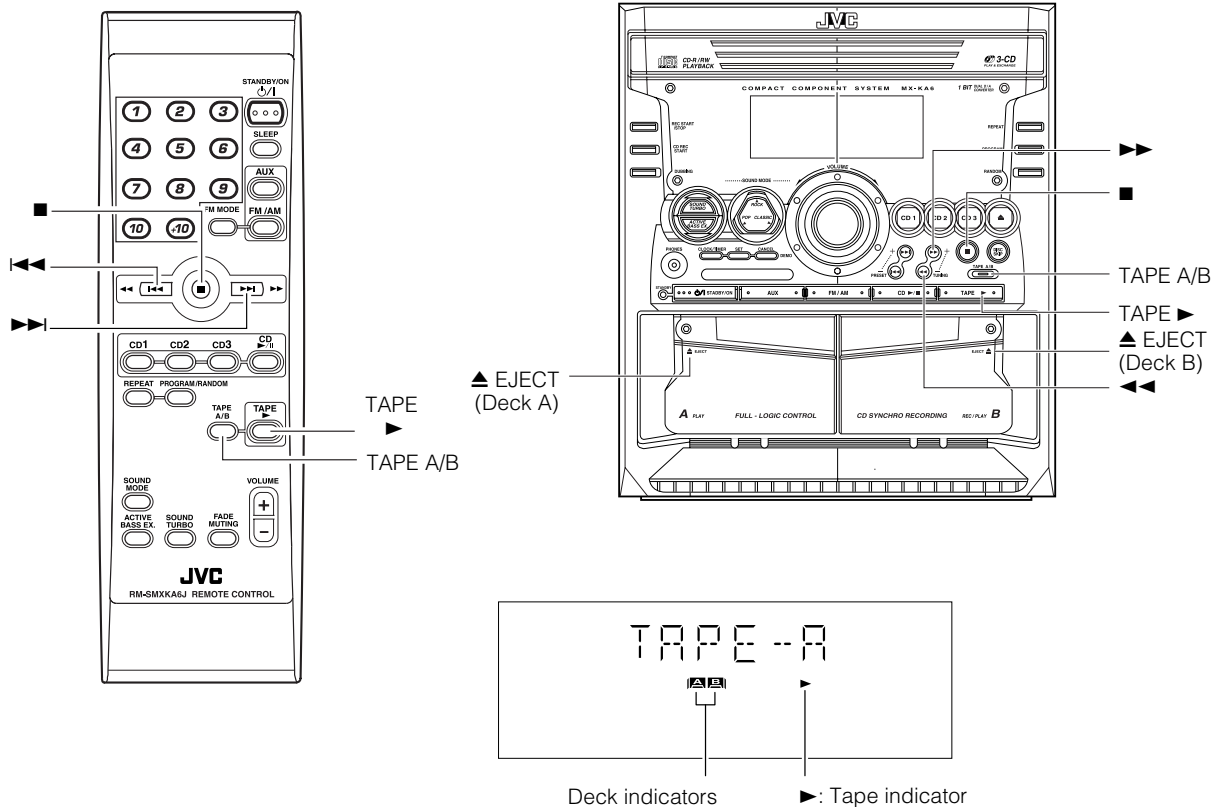

\* When the System is in use, the display shows other items as well. For simplicity, we show here only the items described in this section.

The Cassette Deck allows you to play, record, and dub audio tapes.

□ Listening to type I tape is suitable for this Cassette Deck.

**The use of tapes longer than 120 minutes is not recommended, since characteristic deterioration may occur and these tapes easily jam in the pinch-rollers and the capstans.**

## One Touch Play

By pressing the TAPE ► button, the System will come on, and if a tape is in the deck, it will start to play. If no tape is loaded, "NO TAPE" appears on the display, the System will come on and wait for you to insert a tape, or select another function.

## Playing a Tape

You can use either Deck A or Deck B at a time for playback.

**1 Press the ▲ EJECT part for the deck you want to use.**

**2 When the cassette holder opens, put a cassette in, with the exposed part of the tape down, toward the base of the Unit.**

The tape will travel from the left to right.

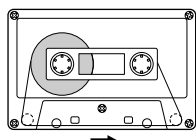

Tape travelling direction

- If the cassette holder does not open, turn the System off, then back on and press the ▲ EJECT part again.

## 3 Close the cassette holder gently.

When both Deck A and Deck B contain a tape, the last deck to have a tape inserted is selected.

The selected Deck is shown by the Deck indicator "A" or "B". For example, when the Deck A is selected, the Deck indicator "A" lights up.

- To change the deck, press the TAPE A/B button. Each time you press the button, Deck A or Deck B is alternately selected.

## 4 Press the TAPE ► button.

The Tape indicator (►) blinks on the display and the tape is played back.

The Cassette Deck automatically stops when one side of the tape has finished playing.

**To stop playing,** press the ■ button.

**To remove the tape,** stop the tape, and press the ▲ EJECT part to open the Cassette Holder.

## To Fast-Wind A Tape

During playback or in Stop mode, press the ►► (FF) button on the Unit to fast-wind the tape onto the right side of the cassette without playing. (You can also use the ►►| button on the Remote Control.) During playback or in Stop mode, press the ◀◀ (REW) button on the Unit to fast-wind the tape onto the left side of the cassette without playing. (You can also use the ◀◀| button on the Remote Control.)

During fast-winding the tape, the Tape indicator (►) goes out.

During fast-winding, the status bar illumination at the bottom of the display moves counterclockwise.

During rewinding, it moves clockwise.

- The Cassette Deck automatically stops when one side of the tape has finished playing.

□ During fast-winding the tape, you can change the tape travelling direction by pressing the ►► (FF) or ◀◀ (REW) button.

# Using the Cassette Deck (Recording)

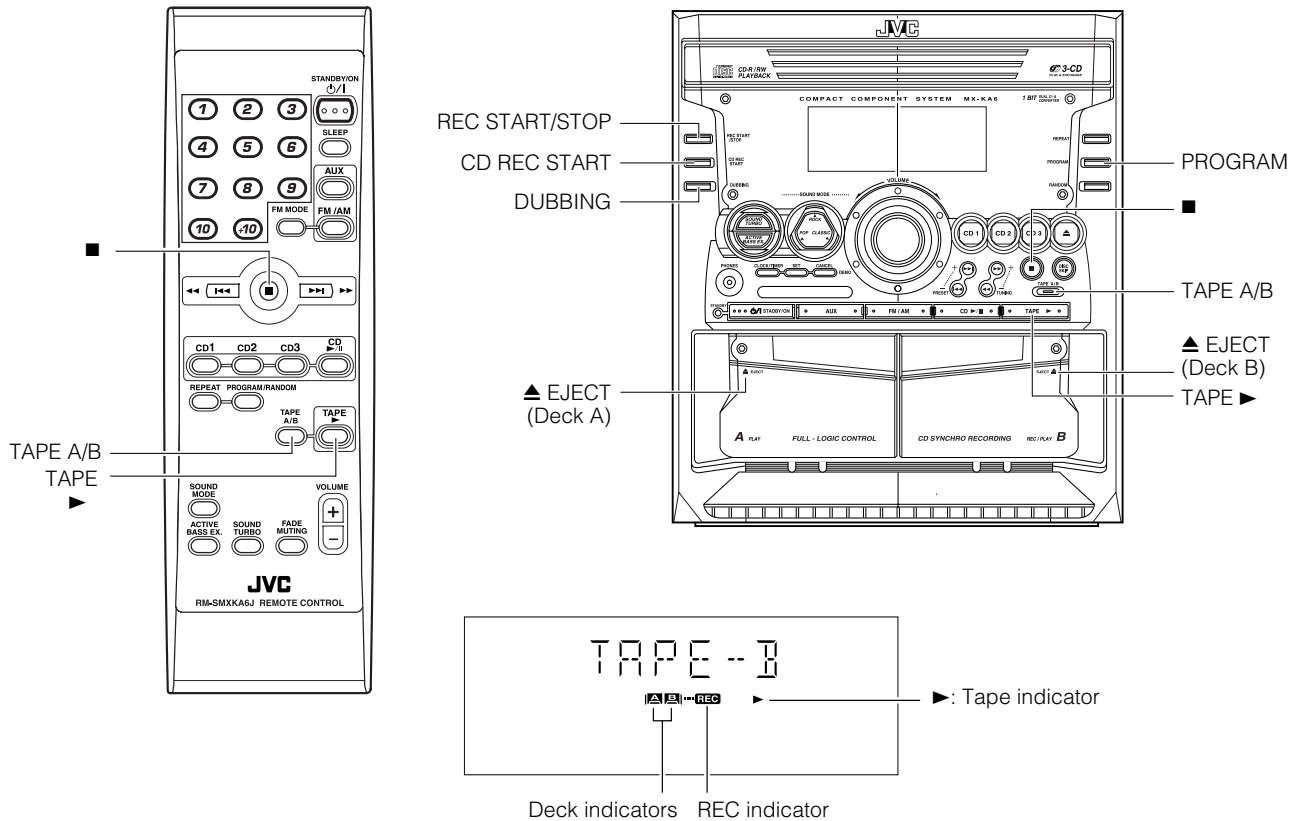

\* When the System is in use, the display shows other items as well. For simplicity, we show here only the items described in this section.

Recording onto a cassette from any of the sound sources is simple. Just place a tape in Deck B, have the source ready, make one or two settings, and you're ready to record. For each source, the procedure is a little bit different so we explain each separately. But first, here are a few things to make your recordings better.

## Things To Know Before You Start Recording

- ❑ It should be noted that it may be unlawful to re-record pre-recorded tapes, records, or discs without the consent of the owner of copyright in the sound or video recording, broadcast or cable program and in any literary, dramatic, musical, or artistic content embodied therein.
- ❑ The recording level, which is the volume at which the new tape is being made, is automatically set correctly, so it is not affected by the VOLUME Control on the System. Also, it is not affected by adjusting the sound effects. Thus, during recording, you can adjust the sound you are actually listening to without affecting the recording level.
- ❑ Two small tabs on the back of the cassette tape, one for side A and one for side B, can be removed to prevent accidental erasure or recording.

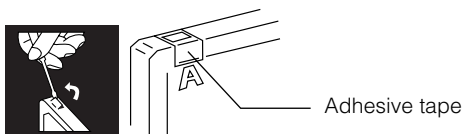

- ❑ To record on a cassette with the tabs removed, you must cover the holes with adhesive tape first.
- ❑ Type I tape can be used for recording.

## Note

- At the start and end of cassette tapes, there is leader tape which cannot be recorded onto. Thus, when recording CDs, radio broadcasts, etc., wind on the leader tape first to ensure getting the beginning of the recording.

## CAUTION:

- If a recording you make has excessive noise or static, the Unit may have been too close to a TV which was on during the recording. Either turn off the TV or increase the distance between the TV and the Unit.

## Standard Recording

This is the basic method for recording any source. The System also has special ways for recording CD to tape, and tape to tape, which save you time and effort, as well as give you some special effects. However, when you need to add a selection to a tape you have made, or are combining selections from several sources on one tape, use the method described below; just substitute the source you want into this procedure, such as a tape in Deck A, a CD, or the Tuner. You can also record from an external equipment with this procedure.

### To Record Any Sound Source to Tape

Follow these steps to record from any sound source onto a tape in Deck B.

#### 1 Insert a blank or erasable tape into the Deck B and wind past the tape leader.

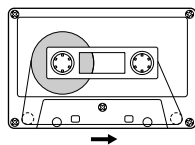

Tape travelling direction

#### 2 Prepare the source, by, for example, tuning in a radio station, loading CDs, or turning on connected equipment.

- For CD recording, see “CD Synchro Recording” mentioned below.
- For dubbing, see “Tape to Tape Recording (Dubbing)” described below.

#### 3 Press the REC START/STOP button on the Unit.

The “REC” indicator lights up and the System begins recording.

The Tape indicator (▶) blinks on the display.

- If the tab of the cassette tape on the Deck B is removed to prevent erasure or recording, “NO REC” will appear on the display.

To stop during recording, press the REC START/STOP button on the Unit, or press the ■ button.

### Recording an AM Station to Tape (Beat Cut)

When recording an AM broadcast, beats may be produced which are not heard when listening to the broadcast. If this happens, press the PROGRAM button on the Unit to eliminate the beats.

#### 1 Set to AM station and start recording.

#### 2 Press the PROGRAM button on the Unit to eliminate the beats.

Each time you press the button, the display changes as shown below:

CUT 1 → CUT 2 → (back to the beginning)

## CD Synchro Recording

Everything on the CD goes onto the tape in the order it is on the CD, or according to the order you have set in a program.

#### 1 Prepare CDs. (See page 12.)

Press the CD1-3 button (that you want to make recording), and then press the ■ button.

- If you want to record specific tracks only, you need to program the tracks beforehand. (See page 14.)
- If you want to record one CD only, you need to load one CD only.

#### 2 Insert a blank or erasable tape into the Deck B and wind past the tape leader.

#### 3 Press the CD REC START button on the Unit.

“CD REC” appears on the display and the “REC” indicator lights up. Then, the System begins CD Synchro Recording and the tracks on the CD are recorded on the tape. When recording of the tracks of all CDs is finished, “CD REC FINISHED” scrolls on the display and the CD Player and Cassette Deck stop.

(Recording start) (When finished)



- If the tab of the cassette tape on the Deck B is removed to prevent erasure or recording, “NO REC” will appear on the display.
- After the CD Player has played the entire CD or all the programmed tracks, the tape automatically stops.

To stop at any time during the recording process, press the REC START/STOP button on the Unit or the ■ button. “CD REC FINISHED” scrolls on the display and the CD Player and Cassette Deck stop.



- When making SLEEP timer settings while doing CD Synchro recording, set enough time to allow for the CD to finish playing, otherwise the power will go off before recording is completed.

## Tape to Tape Recording (DUBBING)

Recording from one tape to another is called dubbing. You can dub tapes simply, with just a single button.

#### 1 Press the TAPE▶ button, and then press the ■ button.

#### 2 Insert the source cassette you want to copy from into Deck A for playback.

#### 3 Insert a blank or erasable cassette you want to copy onto into Deck B for recording.

#### 4 Press the DUBBING button on the Unit.

Deck A and Deck B will start simultaneously and the “REC” indicator lights up.

During dubbing, the Deck indicators “A” and “B” light up alternately.

- If no tape is inserted into Deck A, “NO TAPE” will appear on the display.
- If no tape is inserted into Deck B, “NO TAPE” will appear on the display.

To stop dubbing, press the REC START/STOP button on the Unit or the ■ button.



- During dubbing, you can hear sound effects through the speakers or headphones. However, the sound is dubbed without sound effects.

# Using an External Equipment

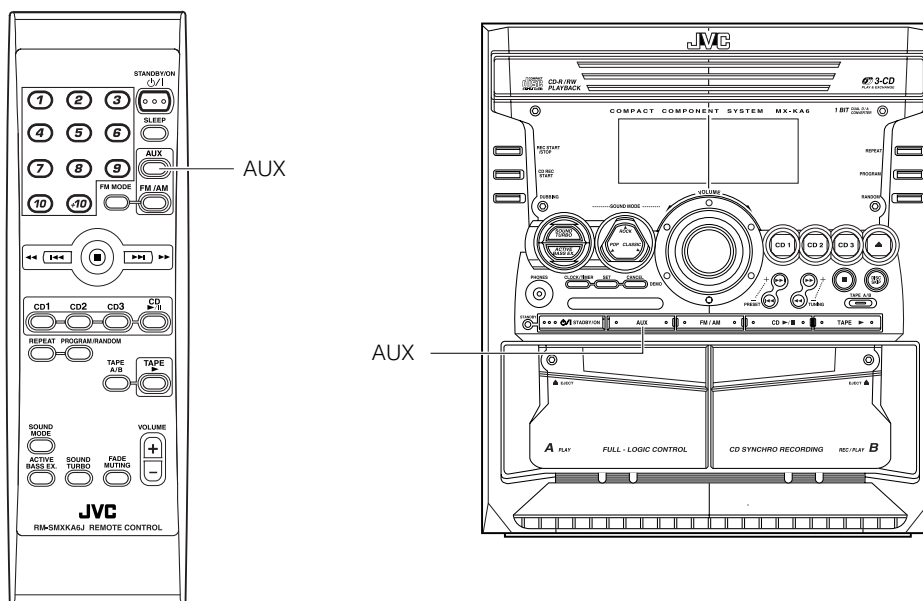

## Listening to the External Equipment

You can listen to the external equipment such as MD recorder, cassette deck, or other auxiliary.

□ First, make sure that the external equipment is properly connected to the System. (See page 6.)

**1** Set the volume level to the minimum position.

**2** Press the AUX button.

“AUX IN” appears on the display.

AUX IN

**3** Start playing the external equipment.

**4** Adjust the volume level to the level you want listen to.

**5** Apply the following sound effects, if you wish.

- ACTIVE BASS EX. (See page 8.)
- SOUND TURBO (See page 8.)
- Sound Mode (See page 8.)

To exit AUX mode, select other source (e.g. Tuner).



• For operation of the external equipment, refer to its Instructions.

# Using the Timers

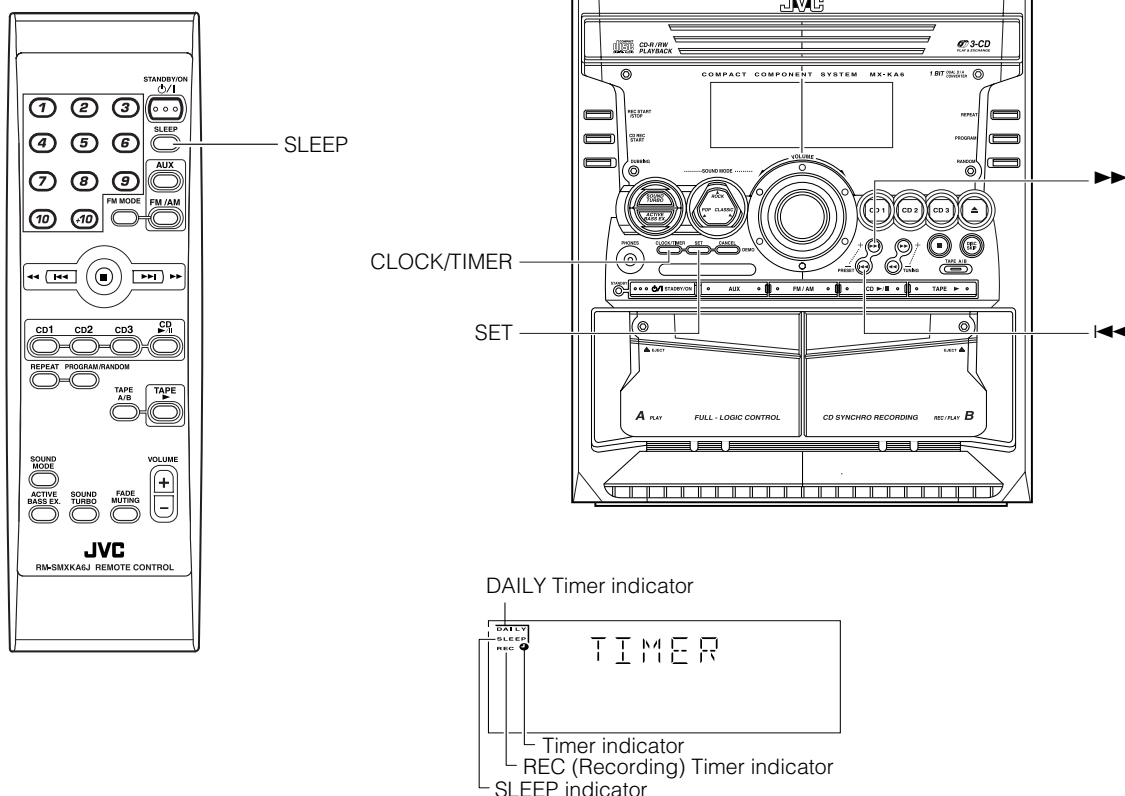

\* When the System is in use, the display shows other items as well. For simplicity, we show here only the items described in this section.

The timers lets you control recording and listening functions automatically.

Three types of timers are available:

### DAILY Timer

Use this timer to set wake up everyday to music from any source, instead of an alarm clock.

### REC (Recording) Timer

Unattended recording of radio broadcasts. You can set the starting time and ending time.

### SLEEP Timer

Fall asleep and have your System turn off automatically after a certain length of time.

## Setting the Clock

When you plug the AC power cord into the wall outlet, the time indication "AM 12:00" blinks on the display.

You can set the clock whether the System is on or off.

### Notes

- The clock must be correctly set for the timers to work.
- Each setting step must be completed within approx. two minutes. Otherwise, the setting is cleared and must be repeated from the beginning.
- The clock may gain or lose one to two minutes per month.

## Using the Unit

### 1 Press the CLOCK/TIMER button.

The hour digit of the time indication blinks on the display.

- If the clock is already set and "AM 12:00" is not blinking, press the CLOCK/TIMER button repeatedly until clock setting display appears on the display. (In the clock setting

display, the hour digits of the current clock blink on the display.)

### Note

- If the clock is already set, the display changes as follows each time you press the CLOCK/TIMER button.  
TIMER → ON TIME → REC → ON TIME → Clock setting display → Canceled → (back to the beginning)

### 2 Press the |◀◀ or ▶▶| button to set the hour.

Pressing the ▶▶ button moves the time forwards and pressing the ◀◀ button moves it backwards. Holding down the button moves the hour rapidly.

### 3 Press the SET button.

The minute digits of the time indication blink on the display.

- To return to the hour setting, press the CANCEL button.

### 4 Press the |◀◀ or ▶▶| button to set the minute.

### 5 Press the SET button.

"CLOCK OK" appears on the display. Then, the selected time is set and the seconds start counting from 0.

### CAUTION:

- If there is a power failure, the clock loses its setting immediately. "AM 12:00" blinks on the display and the clock must be reset.

## Setting the Daily Timer

Once you have set the Daily Timer, the timer will be activated at the same time every day.

The Timer indicator (●) and “DAILY” indicator on the display shows that the Daily Timer you have set is in effect.

You can set the Daily Timer whether the System is turned on or off.

### Notes

- Perform each setting within approx. 30 seconds. Otherwise, setting will be cleared and the procedure must be repeated from the beginning.
- If you have made a mistake while setting the timer, press the CANCEL button on the Unit. However, this does not always cancel the current setting. If the CANCEL button does not work, press the CLOCK/TIMER button on the Unit repeatedly until the display returns to the original display, and start from the first step.

## Using the Unit

**1** Press the  STANDBY/ON button to turn on the System.

**2** Press the CLOCK/TIMER button until “ON TIME” immediately after “TIMER” appears on the display.

At this time, “DAILY” indicator blinks and the Timer indicator (●) lights up on the display.



Each time you press the button, the display changes as follows: TIMER → ON TIME\* → REC → ON TIME → Clock setting display → Canceled → (back to the beginning)

\*: This item should be selected for the Daily Timer setting.

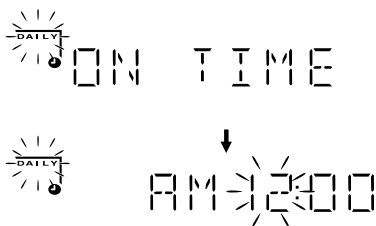

Then, the System enters ON-time setting mode, and the current ON time appears on the display and the hour digits blink.



**3** Setting the ON time (Example: AM 10:15).



1. Press the  or  button to set the hour you want the System to come on, then press the SET button.

The minute digits of the ON time blink on the display.

Pressing the  button moves the time forwards and pressing the  button moves it backwards.

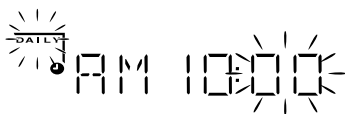
Holding down the button moves the time rapidly.





2. Press the  or  button to set the minute, then press the SET button.

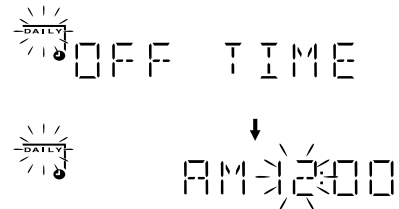

“OFF TIME” appears and then the System enters OFF-time setting mode. The current OFF time appears on the display, and the hour digits blink.





**4** Setting the OFF time (Example: PM 1:15).

1. Press the  or  button to set the hour you want the System to be turned off, then press the SET button.

The minute digits of the ON time blink on the display.





2. Press the  or  button to set the minute, then press the SET button.





The System enter Music Source Selecting mode and “TUNER FM” appears on the display.



**5** Selecting the music source.

Press the  or  button to select the music source you want to listen to, then press the SET button.

Each time you press the  or  button, the display changes as shown below:

TUNER FM → TUNER AM → - CD - - → TAPE → AUX IN → (back to the beginning)

According to the music source you have selected, the next operation differs.

**TUNER FM:** Tunes in to the specified preset FM station.

**TUNER AM:** Tunes in to the specified preset AM station.

**- CD - - :** Plays the specified track on the specified CD.

**TAPE:** Plays a tape in Deck A.

**AUX IN:** Plays an external source.



**Preparation for each music source:**

Perform the following operation according to the music source you have selected. Then, the System enters Volume Setting mode.

**When selecting TUNER FM or TUNER AM:**

Press the ►► or ◄◄ button to select the preset station number, then press the SET button.

**When selecting – CD – – :**

Be sure to specify the disc number and the track number as follows.

1. Press the ►► or ◄◄ button to select the disc number, then press the SET button.

Each time you press the button the disc number changes as follows:

– CD – – → 1 CD – – → 2 CD – – → 3 CD – – → (back to the beginning)

- If no disc number is specified, playback will start from the first track of the currently selected disc.

2. Press the ►► or ◄◄ button to select the track number, then press the SET button.

For example: 2 CD12 (Disc number 2, Track number 12)

Set Daily timer CD2 after playing in CD2.

If you set Daily Timer to other CD number after playing CD2, it will not play back at the setting time.

- If no track number is specified, playback will start from the first track of the specified disc.

**When selecting TAPE:**

Insert a cassette tape you want to play into Deck A.

**When selecting AUX:**

Prepare the external equipment so that it will turn on at the ON time set by the System.

To allow this, the equipment should have the timer function.

**6 Setting the volume level.**

Press the ►► or ◄◄ button to select the volume level.

**VOL – – :** The current volume level will be used.

**VOL5, 10, or 15:** When the timer is turned on, the Volume will be automatically set to the selected level.

**7 Press the SET button.**

The timer setting is completed and “SET” and “OK” successively appear on the display. Then the display returns to the display before you set the Timer.

**8 Press the ⏻/| STANDBY/ON button to turn off the System.**

The Timer indicator (⦿) and “DAILY” indicator are lit on the display, showing that the Daily Timer is set to on.

**To confirm / change the timer setting,** repeat the setting procedure from the beginning.

**When the timer ON-time comes:**

The following operation will be automatically repeated every day.

- When the timer ON-time comes, and the System automatically turns on. The music source you have set is played. The Timer indicator (⦿) blinks and “DAILY” indicator lights during timer operation.
- When the timer OFF-time comes, “OFF” blinks on the display just before the OFF-time and the System automatically turns off. Then, the Timer indicator (⦿) and “DAILY” indicator remain lit on the display.



- If the System is already on when the timer ON-time comes, the Daily Timer does not work.

**Turning the Daily Timer On and Off**

Once you have set the Daily Timer, it is stored in memory. So, the Daily Timer will be activated at the same time every day until it is canceled.

**To cancel the Daily Timer temporarily:**

- 1 Press the CLOCK/TIMER button on the Unit repeatedly until the “TIMER” appears on the display.**

- 2 Press the CANCEL button on the Unit.**

The “DAILY” indicator goes out and “OFF” appears on the display.

The Timer indicator (⦿) goes out and the Daily Timer is canceled temporarily.

**To activate the cancelled Daily Timer:**

- 1 Press the CLOCK/TIMER button on the Unit repeatedly until the “TIMER” appears on the display.**

The “DAILY” indicator blinks and the Timer indicator (⦿) lights up on the display.

- 2 Press the SET button on the Unit.**

“SET” and “OK” successively appear on the display. The Timer indicator (⦿) and the “DAILY” indicator remain lit, and the display returns to the original display.

**CAUTION:**

- If the System is unplugged, or a power failure occurs, the timer setting will be lost in a few days. You will need to reset the clock first, then the timer.

**Setting the REC (Recording) Timer**

With the Recording Timer, you can make a tape of a radio broadcast automatically whether or not you are home.



- You can set the REC Timer whether the System is on or off.
- The volume level is automatically set to MIN when REC Timer is used.
- Perform each setting within approx. 30 seconds. Otherwise, setting will be cleared and the procedure must be repeated from the beginning.
- If you have made a mistake while setting the timer, press the CANCEL button on the Unit. However, this does not always cancel the current setting. If the CANCEL button does not work, press the CLOCK/TIMER button on the Unit repeatedly until the display returns to the original display, and start from the first step.

## Using the Timers

### Using the Unit

You can set the time in the same way as for setting the Daily Timer.

#### 1 Insert a blank or erasable tape into the Deck B and wind past the tape leader.

#### 2 Press the CLOCK/TIMER button until "ON TIME" immediately after "REC" appears on the display.

The Timer indicator (●) lights and the "REC" indicator blinks.

Each time you press the button, the display changes as follows: DAILY → ON TIME → REC → ON TIME\* → Clock setting display → Canceled → (back to the beginning)

\*: This item should be selected for the REC Timer setting.

Then, the System enters ON-time setting mode. The current ON time appears on the display and the hour digits blink.

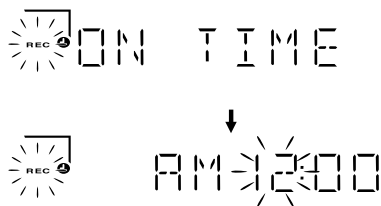

#### 3 Setting the ON time you want the System to turn on.

1. Press the ◀◀ or ▶▶ button to set the hour, then press the SET button.

2. Press the ◀◀ or ▶▶ button to set the minute, then press the SET button.

"OFF TIME" appears and then the System enters OFF-time setting mode. The current OFF time appears on the display, and the hour digits blink.

#### 4 Setting the OFF time you want the System to turn off.

1. Press the ◀◀ or ▶▶ button to set the hour, then press the SET button.

2. Press the ◀◀ or ▶▶ button to set the minute, then press the SET button.

The System enter Preset Station Entering mode.

#### 5 Select the preset station for recording.

1. Press the ◀◀ or ▶▶ button to set the band (TUNER FM or TUNER AM), then press the SET button.

2. Press the ◀◀ or ▶▶ button to set the preset number, then press the SET button.

"SET" and "OK" successively appear on the display. The "REC" indicator stops blinking and remains lit.

#### 6 Press the ⏻/| STANDBY/ON button to turn off the System, if necessary.

To confirm / change the timer setting, repeat the setting procedure from the beginning.

### When the timer ON-time comes:

- When the timer ON-time comes, the System automatically turns on. The station you have set is played. The Timer indicator (●) blinks during timer operation. To stop timer recording, press the ■ button.
- When the timer OFF-time comes, "OFF" blinks on the display just before the OFF-time and the System automatically turns off.



- The REC Timer works even if the System is turned on.

### Turning the REC (Recording) Timer On and Off

Once you have set the REC Timer to record a source, the timer setting is stored in memory. So, though the REC Timer turns off once it is used, you can recall it at any time.

#### To cancel the REC Timer temporarily:

#### 1 Press the CLOCK/TIMER button on the Unit repeatedly until "REC" appears on the display.

#### 2 Press the CANCEL button on the Unit.

"OFF" appears and both the Timer indicator (●) and the "REC" indicator go out.

#### To activate the cancelled REC Timer:

#### 1 Press the CLOCK/TIMER button on the Unit repeatedly until "REC" appears on the display.

The Timer indicator (●) lights and the "REC" indicator blink on the display.

#### 2 Press the SET button on the Unit.

"SET" and "OK" successively appear on the display. The Timer indicator (●) and the "REC" indicator remain lit, and the display returns to the original display.

### CAUTION:

- If the System is unplugged, or a power failure occurs, the timer setting will be lost in a few days. You will need to reset the clock first, then the timer.

## Setting the SLEEP Timer

Use the Sleep Timer to turn the System off after a certain number of minutes when it is playing. By setting the Sleep Timer, you can fall asleep to music and know that your System will turn off by itself rather than play all night.

- You can only set the Sleep Timer when the System is on.

### Using the Remote Control

#### 1 During playback a source, press the SLEEP button.

The “SLEEP” indicator starts blinking on the display.

#### 2 Set the length of time you want the source to play before shutting off.

Each time you press the SLEEP button, the time length changes as follows:

10 → 20 → 30 → 60 → 90 → 120 → Cancelled → (back to the beginning)

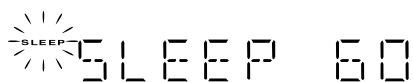

#### 3 Wait for 5 seconds.

The “SLEEP” indicator stops blinking and remains lit, and the display returns to the original one before setting the Sleep Timer.

The System is now set to turn off after the number of minutes you have set.

#### To Confirm the Sleep Time:

When the SLEEP button on the Remote Control is pressed, the remaining sleep time is displayed. Wait until the display returns to the original display.

#### To Cancel the SLEEP Timer Setting:

Press the SLEEP button on the Remote Control until the “SLEEP” indicator goes out on the display.

- Turning off the System also cancels the SLEEP Timer.



- When the SLEEP button is used without setting the clock, “CLOCK ADJUST” appears on the display. You need to set the clock beforehand.

## Timer Priority

Since each timer can be set independently, you may wonder what happens if the settings overlap. Here are the priorities for each timer: The REC Timer always has priority. This means that:

- If other timer is set to come on during a time when the REC Timer is operating, the other timer just won't come on at all, so you will always get the entire program on a tape.
  - If the REC Timer is set to come on while other timer is operating, the other timer will turn off just before the REC Timer is set to turn on, and the REC Timer will then take over.
- If the SLEEP Timer is set while DAILY Timer is operating, the DAILY Timer settings are cancelled. However, if DAILY Timer is set to come on while the SLEEP Timer is operating, the SLEEP Timer setting will be cancelled and the System will use the settings from the DAILY Timer.

### Example 1

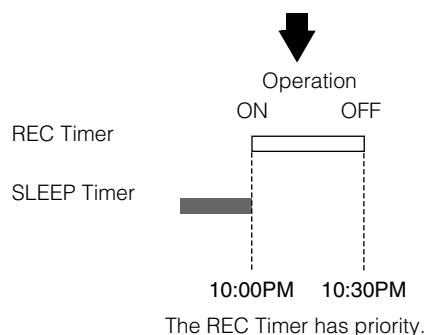
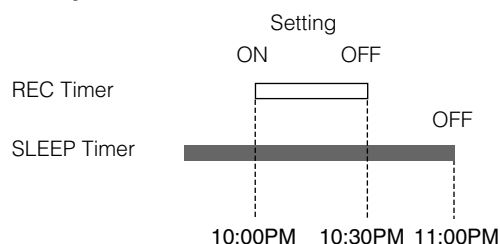

### Example 2

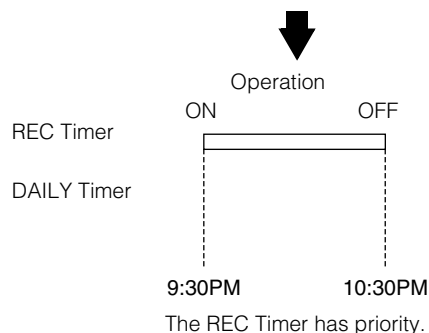
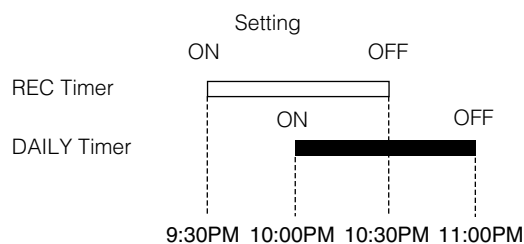

# Care And Maintenance

Handle your CDs and tapes carefully, and they will last a long time.

## Compact Discs

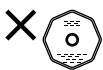
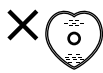

- Only CDs bearing these marks can be used with this System. However, continued use of irregular shape CDs (heart-shape, octagonal, etc.) can damage the System.

- Remove the CD from its case by holding it at the edges while pressing the case's center hole lightly.
- Do not touch the shiny surface of the CD, or bend the CD.

- Put the CD back in its case after use to prevent warping.
- Be careful not to scratch the surface of the CD when placing it back in the case.
- Avoid exposure to direct sunlight, temperature extremes, and moisture.

- A dirty CD may not play correctly. If a CD does become dirty, wipe it with a soft cloth in a straight line from center to edge.

## CAUTION:

- Do not use any solvent (for example, conventional record cleaner, spray thinner, benzine, etc.) to clean a CD.

## General Notes

In general, you will have the best performance by keeping your CDs and the mechanism clean.

- Store CDs in their cases, and keep them in cabinets or on shelves.
- Keep the System's Top Cover closed when not in use.

## Moisture Condensation



Moisture may condense on the lens inside the System in the following cases:

- After turning on heating in the room.
- In a damp room.
- If the System is brought directly from a cold to a warm place.

Should this occur, the System may malfunction. In this case, leave the System turned on for a few hours until the moisture evaporates, unplug the AC power cord, and then plug it in again.

## Cassette Tapes



- If the tape is loose in its cassette, take up the slack by inserting a pencil in one of the reels and rotating.
- If the tape is loose, it may get stretched, cut, or caught in the cassette.



- Do not touch the tape surface.



- Do not store the tape:
  - In dusty places
  - In direct sunlight or heat
  - In moist areas
  - On a TV or speaker
  - Near a magnet

## Cassette Deck

- If the heads, capstans, and pinch-rollers of the Cassette Deck become dirty, the following will occur:
  - Loss of sound quality
  - Discontinuous sound
  - Fading
  - Incomplete erasure
  - Difficulty recording
- Clean the heads, capstans, and pinch-rollers using a cotton swab moistened with alcohol.

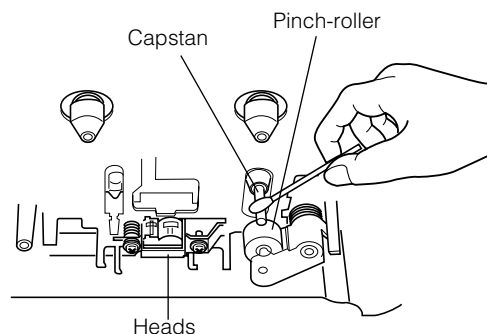

- If the heads become magnetized, the Unit will produce noise or lose high frequencies.
- To demagnetize the heads, turn off the Unit, and use a head demagnetizer (available at electronics and record shops).

# Troubleshooting

- If you are having a problem with your System, check this list for a possible solution before calling for service.
- If you cannot solve the problem from the hints given here, or the System has been physically damaged, call a qualified person, such as your dealer, for service.

Symptom	Possible Cause	Action
No sound is heard.	<ul style="list-style-type: none"> <li>• Connections are incorrect, or loose.</li> <li>• Headphones are connected.</li> </ul>	<ul style="list-style-type: none"> <li>• Check all connections and make corrections. (See pages 4 to 6.)</li> <li>• Disconnect the headphones.</li> </ul>
Poor radio reception	<ul style="list-style-type: none"> <li>• The antenna is disconnected.</li> <li>• The AM Loop Antenna is too close to the System.</li> <li>• The FM Wire Antenna is not properly extended and positioned.</li> </ul>	<ul style="list-style-type: none"> <li>• Reconnect the antenna securely.</li> <li>• Change the position and direction of the AM Loop Antenna.</li> <li>• Extend FM Wire Antenna to the best reception position.</li> </ul>
The disc tray does not open.	<ul style="list-style-type: none"> <li>• The AC power cord is not plugged in.</li> <li>• Tray is locked.</li> </ul>	<ul style="list-style-type: none"> <li>• Plug the AC power cord.</li> <li>• Unlock the tray. (See page 15.)</li> </ul>
The CD skips.	The CD is dirty or scratched.	Clean or replace the CD. (See page 25.)
The CD does not play.	The CD is upside down.	Put the CD in with the label side up.
The cassette holder cannot be opened.	During tape playing, the power cord was unplugged.	Plug in the power cord, and turn on the System.
Unable to record.	Cassette record protect tabs are removed.	Cover holes on back edge of cassette with tape.
Unable to operate the Remote Control.	<ul style="list-style-type: none"> <li>• The path between the Remote Control and the sensor on the Unit is blocked.</li> <li>• The batteries have lost their charge.</li> </ul>	<ul style="list-style-type: none"> <li>• Remove the obstruction.</li> <li>• Replace the batteries.</li> </ul>
Operations are disabled.	The built-in microprocessor has malfunctioned due to external electrical interference.	Unplug the System then plug it back in.

# Authorized Service Centers

---

QUALITY **JVC**<sup>®</sup> SERVICE

*HOW TO LOCATE YOUR JVC SERVICE CENTER*

**TOLL FREE: 1 (800) 537-5722**

**<http://www.jvc.com>**

Dear Customer,

In order to receive the most satisfaction from your purchase, please read the instruction booklet before operating the unit. In the event that repairs are necessary, please call 1 (800)537-5722 for your nearest authorized servicer or visit our website at **[www.JVC.com](http://www.JVC.com)**

Remember to retain your Bill of Sale for Warranty Service.

---

## **Do not service the television yourself**

---

### **Caution**

To prevent electrical shock, do not open the cabinet. There are no user serviceable parts inside. Please refer to qualified service personnel for repairs.

### **Accessories**

To purchase accessories for your JVC product, please call toll free: 1 (800)882-2345 or on the web at **[www.JVC.com](http://www.JVC.com)**

---



# LIMITED WARRANTY

AUDIO-1

JVC COMPANY OF AMERICA warrants this product and all parts thereof, except as set forth below ONLY TO THE ORIGINAL PURCHASER AT RETAIL to be FREE FROM DEFECTIVE MATERIALS AND WORKMANSHIP from the date of original retail purchase for the period as shown below. ("The Warranty Period")

PARTS	<b>1 YR</b>	LABOR	<b>1 YR</b>
-------	-------------	-------	-------------

THIS LIMITED WARRANTY IS VALID ONLY IN THE FIFTY (50) UNITED STATES, THE DISTRICT OF COLUMBIA AND IN COMMONWEALTH OF PUERTO RICO.

**WHAT WE WILL DO:**

If this product is found to be defective, JVC will repair or replace defective parts at no charge to the original owner. Such repair and replacement services shall be rendered by JVC during normal business hours at JVC authorized service centers. Parts used for replacement are warranted only for the remainder of the Warranty Period. All products and parts thereof may be brought to a JVC authorized service center on a carry-in basis except for Television sets having a screen size 25 inches and above which are covered on an in-home basis.

**WHAT YOU MUST DO FOR WARRANTY SERVICE:**

Return your product to a JVC authorized service center with a copy of your bill of sale. For your nearest JVC authorized service center, please call toll free: (800) 537-5722.

If service is not available locally, box the product carefully, preferably in the original carton, and ship, insured, with a copy of your bill of sale plus a letter of explanation of the problem to the nearest JVC Factory Service Center, the name and location of which will be given to you by the toll-free number.

If you have any questions concerning your JVC Product, please contact our Customer Relations Department.

**WHAT IS NOT COVERED:**

This limited warranty provided by JVC does not cover:

1. Products which have been subject to abuse, accident, alteration, modification, tampering, negligence, misuse, faulty installation, lack of reasonable care, or if repaired or serviced by anyone other than a service facility authorized by JVC to render such service, or if affixed to any attachment not provided with the products, or if the model number or serial number has been altered, tampered with, defaced or removed;
2. Initial installation and installation and removal for repair;
3. Operational adjustments covered in the Owner's Manual, normal maintenance, video and audio head cleaning;
4. Damage that occurs in shipment, due to act of God, and cosmetic damage;
5. Signal reception problems and failures due to line power surge;
6. Video Pick-up Tubes/CCD Image Sensor, Cartridge, Stylus (Needle) are covered for 90 days from the date of purchase;
7. Accessories
8. Batteries (except that Rechargeable Batteries are covered for 90 days from the date of purchase);

There are no express warranties except as listed above.

THE DURATION OF ANY IMPLIED WARRANTIES, INCLUDING THE IMPLIED WARRANTY OF MERCHANTABILITY, IS LIMITED TO THE DURATION OF THE EXPRESS WARRANTY HEREIN.

JVC SHALL NOT BE LIABLE FOR THE LOSS OF USE OF THE PRODUCT, INCONVENIENCE, LOSS OR ANY OTHER DAMAGES, WHETHER DIRECT, INCIDENTAL OR CONSEQUENTIAL (INCLUDING, WITHOUT LIMITATION, DAMAGE TO TAPES, RECORDS OR DISCS) RESULTING FROM THE USE OF THIS PRODUCT, OR ARISING OUT OF ANY BREACH OF THIS WARRANTY. ALL EXPRESS AND IMPLIED WARRANTIES, INCLUDING THE WARRANTIES OF MERCHANTABILITY AND FITNESS FOR PARTICULAR PURPOSE, ARE LIMITED TO THE WARRANTY PERIOD SET FORTH ABOVE.

Some states do not allow the exclusion of incidental or consequential damages or limitations on how long an implied warranty lasts, so these limitations or exclusions may not apply to you. This warranty gives you specific legal rights and you may also have other rights which vary from state to state.

JVC COMPANY OF AMERICA                      1700 Valley Road  
 DIVISION OF JVC AMERICAS CORP.        Wayne, NJ 07470

REFURBISHED PRODUCTS CARRY A SEPARATE WARRANTY, THIS WARRANTY DOES NOT APPLY. FOR DETAILS OF REFURBISHED PRODUCT WARRANTY, PLEASE REFER TO THE REFURBISHED PRODUCT WARRANTY INFORMATION PACKAGED WITH EACH REFURBISHED PRODUCT.

**For customer use:**

Enter below the Model No. which is located either on the rear, bottom or side of the cabinet. Retain this information for future reference.

Model No. : \_\_\_\_\_ Serial No. : \_\_\_\_\_  
 Purchase data : \_\_\_\_\_ Name of dealer : \_\_\_\_\_

# Specifications

## Amplifier

Output Power 150 W per channel, min. RMS, driven into 6  $\Omega$  at 1kHz, with no more than 10% total harmonic distortion

## Input Sensitivity/Impedance (1 kHz)

AUX IN 300 mV/50 k $\Omega$   
Speaker terminals 6 - 16  $\Omega$   
Phones 32  $\Omega$  - 1 k $\Omega$   
15 mW/ch output into 32  $\Omega$

## Cassette Deck Section

Frequency Response  
Type I (NORMAL) 63 Hz - 12 500 Hz  
Wow And Flutter 0.15% (WRMS)

## CD Player

CD Capacity 3 CDs  
Dynamic Range 85 dB  
Signal-To-Noise Ratio 85 dB  
Wow And Flutter Unmeasurable

## Tuner

FM Tuner  
Tuning Range 87.5 MHz - 108.0 MHz  
AM Tuner  
Tuning Range 530 kHz - 1 710 kHz

## Unit

Dimensions 267 mm  $\times$  305 mm  $\times$  433 mm (W/H/D)  
(10-9/16"  $\times$  12-1/16"  $\times$  17-1/16")  
Mass Approx. 8.7 kg (19.2 lbs)

## Speaker Specifications (each unit)

SP-MXKA6  
Type 3-way bass-reflex type  
Speaker Unit Woofer: 16 cm (6-5/16") cone  $\times$  1  
Mid: 5cm (2") cone  $\times$  1  
Tweeter: 2 cm (13/16") dome  $\times$  1  
Power Handling Capacity 150 W  
Impedance 6  $\Omega$   
Frequency Range 45 Hz - 22,000 Hz  
Sound pressure level 87 dB/W·m  
Dimensions 244 mm  $\times$  321 mm  $\times$  258 mm (W/H/D)  
(9-5/8"  $\times$  12-11/16"  $\times$  10-3/16")  
Mass Approx. 3.6 kg (8.0 lbs)

## Accessories

AM Loop Antenna (1)  
Remote Control (1)  
Batteries R6P (SUM-3)/AA (15F) (2)  
FM Wire Antenna (1)

## Power Specifications

Power Requirements AC 120 V $\sim$ , 60 Hz  
Power Consumption 135 W (power on mode)  
18 W (in Standby mode)

*Design and specifications are subject to change without notice.*

# JVC

VICTOR COMPANY OF JAPAN, LIMITED



EN

© 2003 VICTOR COMPANY OF JAPAN, LIMITED



0203NYMCREBET